



Modern Series

All-in-One PC

Modern AM272P 1MG (MS-AF82)

Service Guide

Contents

Copyright and Trademarks Notice.....	6
Revision	6
How to Use this Service Guide	6
Safety Instructions	7
Power.....	7
Battery.....	7
Environment	7
Conditional Warranty Service.....	8
Upgrade and Service.....	8
Data Sanitization.....	8
Publicly Available Service Information	9
Disassembly & Assembly.....	11
Product Components and Accessories	12
Product Upgradeability and Repairability	13
Recommended Tools	14
Screw List	15
Preparation for Disassembly	16
Stand	18
Stand Disassembly.....	18
Stand Assembly.....	19
Rear Cover & Panel Rear Cover.....	20
Rear Cover & Panel Rear Cover Disassembly.....	20
Rear Cover & Panel Rear Cover Assembly.....	21
Stand Bracket	22
Stand Bracket Disassembly.....	22
Stand Bracket Assembly.....	23

Mainboard Shield	24
Mainboard Shield Disassembly.....	24
Mainboard Shield Assembly.....	25
Speakers	26
Speaker Disassembly.....	26
Speaker Assembly.....	27
Fan & Thermal Module	28
Fan & Thermal Module Disassembly.....	28
Fan & Thermal Module Assembly	29
Memory Module.....	30
Memory Module Disassembly.....	30
Memory Module Assembly.....	31
Solid State Drive	32
Solid-State Drive Disassembly	32
Solid-State Drive Assembly	33
Wireless Card	34
Wireless Card Disassembly.....	34
Wireless Card Assembly	35
Coin Battery	36
Coin Battery Disassembly.....	37
Coin Battery Assembly.....	37
Mainboard	38
Mainboard Disassembly.....	38
Mainboard Assembly.....	39
TPM Module.....	40
TPM Module Disassembly.....	40
TPM Module Assembly.....	41
Navi Board	42
Navi Board Disassembly	42
Navi Board Assembly	43

Converter Board	44
Converter Board Disassembly	44
Converter Board Assembly	45
Hard Drive (Optional).....	46
Hard Drive Disassembly.....	46
Hard Drive Assembly.....	47
Deco Strip.....	48
Deco Strip Disassembly	48
Deco Strip Assembly	49
LCD Bezel & Panel.....	50
LCD Bezel & Panel Disassembly	50
LCD Bezel & Panel Assembly.....	51
Webcam Module.....	52
Webcam Module Disassembly	52
Webcam Module Assembly.....	53
Powering Up After Maintenance	54
OSD Setup	55
Navi Key.....	55
OSD Setup via Navi Key	56
Image	56
Input Source	57
Setting	57
Troubleshooting	58
Recycling Guidelines.....	60
Stand.....	60
Rear Cover & Panel Rear Cover	64
Deco Strip.....	65
LCD Bezel.....	66
External Power Supply.....	68
Product End-of-Life Instructions	69
Purpose	69
Information on Component and Material Identification	69
Product Take-Back Service.....	70

Using MSI Center	71
Login and Register	72
Create an Account	72
Product Registration	73
Feature Sets	74
Hardware Monitoring	75
Features	76
MSI Recovery	77
System Diagnosis	79
Support	80
Live Update	80
System Info	81
Service	82

Copyright and Trademarks Notice

Copyright © 2023 Micro-Star Int'l Co., Ltd. All rights reserved.

The MSI logo used is a registered trademark of Micro-Star Int'l Co., Ltd. Third-party trademarks and names are the properties of their respective owners. No warranty as to accuracy or completeness is expressed or implied. MSI reserves the right to make changes to this document without prior notice.

Revision

V1.0, 2024/01

How to Use this Service Guide

This Service Guide provides in-depth illustration of disassembling/assembling the product. Since the topics in this guide may be related, it is recommended that you read it from cover to cover first. After that, you may go directly to any specific topic that most meets your immediate needs.

Safety Instructions

Adhere to safety precautions when handling the product to prevent harm or damage to individuals or the product's functionality.

Power

- If the power cord comes with a 3-pin plug, do not disable the protective earth pin from the plug. The monitor must be connected to an earthed mains socket-outlet.
- Disconnect all power sources and place the product on a steady surface before disassembly/assembly.
- When unplugging the power cord, always hold the connector part of the cord. Never pull the cord directly.
- Place the power cord in a way that people are unlikely to step on it. Do not place anything on top of the power cord.
- If this product comes with an adapter, use only the MSI provided AC adapter approved for use with this product.

Battery

Please take special precautions if this product comes with a battery.

- Danger of explosion if battery is incorrectly replaced. Replace only with the same or equivalent type recommended by the manufacturer.
- Avoid disposal of a battery into fire or a hot oven, or mechanically crushing or cutting of a battery, which can result in an explosion.
- Avoid leaving a battery in an extremely high temperature or extremely low air pressure environment that can result in an explosion or the leakage of flammable liquid or gas.
- Do not ingest battery. If the coin/button cell battery is swallowed, it can cause severe internal burns and can lead to death. Keep new and used batteries away from children.

Environment

- Do not place the product in environments subject to mist, smoke, vibration, excessive dust, salty or greasy air, or other corrosive gases and fumes.
- To avoid electrostatic discharge, use an anti-static wrist strap before handling components. Always handle electrostatic-sensitive components, parts, and assemblies only at static-free work areas.
- Handle components with care. Do not touch the pins or contacts on a component.
- Place components on a grounded anti-static pad or on the bed that came with the components whenever the components are separated from the product.
- Handle the display panel with extra care as it is fragile and could break.
- Do not perform any maintenance with wet hands.
- Prevent foreign substances, such as water, other liquids or chemicals, from entering the product while performing disassembly/assembly.
- After assembly, ensure that all screws are replaced and no stray screws remain inside the product.

Conditional Warranty Service

MSI provides a conditional warranty service for selected models. Please visit [MSI Member Center](#) for further information.

Upgrade and Service

Available hardware features may only be offered as part of an upgrade, repair, or replacement service offered by MSI or an authorized service provider.

MSI offers customers replacement parts, product repair and services for 3 years from the date of sale for all EPEAT-registered products.

Damages caused by servicing of products not authorized by MSI or the use of modified or non-MSI authorized parts or components are not covered by MSI Limited Warranty Agreement.

Visit [MSI Service Location](#) to obtain these services offered by MSI.

Go to [MSI Web Ticket](#) to receive further assistance if needed.

Data Sanitization

MSI will not assume any responsibility or confidentiality obligation for the security of any data stored on the equipment submitted for recycling. Users are advised to back up and remove all data from the computers.

Before recycling, we recommend that users follow instructions on [Data Sanitization](#) to permanently and irreversibly remove all personal files, applications and settings from the computers.

Publicly Available Service Information

Service Information	Section
Disassembly instructions including identifying the required tools.	<u>Product Components and Accessories</u> <u>Recommended Tools</u>
Exploded diagram of parts.	<u>Product Components and Accessories</u>
List of spare parts including manufacturer-approved spare parts and how to obtain them.	<u>Product Upgradeability and Repairability</u>
Maintenance procedures or guidance on where to obtain the procedures.	<u>System Diagnosis</u>
Troubleshooting instructions, software diagnostic tools, troubleshooting videos or other troubleshooting guidance.	<u>Troubleshooting</u> <u>Service > Troubleshooting</u>
Instructions on how to obtain software updates (not applicable to display products).	<u>Support</u>
Instructions on how the user can remove personal data. If the instructions require destruction of the storage, instructions to replace the storage shall be provided (not applicable to display products).	<u>Data Sanitization</u>

It is acceptable for service instructions to exclude information that, as determined by the manufacturer:	
a) May expose the user to risk of injury, or	N/A
b) Breaches intellectual property rights, or	N/A
c) Compromises user privacy or security, or	N/A
d) Involves the disassembly of a battery pack or power supply	N/A
If claiming any of the four exclusions above the manufacturer shall demonstrate how the product is restored to normal operating condition after being repaired. Repair may include replacement of the component[s] associated with the exclusion.	N/A

Disassembly & Assembly

Product Components and Accessories

Important

MSI provides the below list of components for the system configuration purchased and within 2 years after discontinuation of the product to increase the operational life of that product. Further services can be obtained by contacting [MSI Online Customer Service](#).

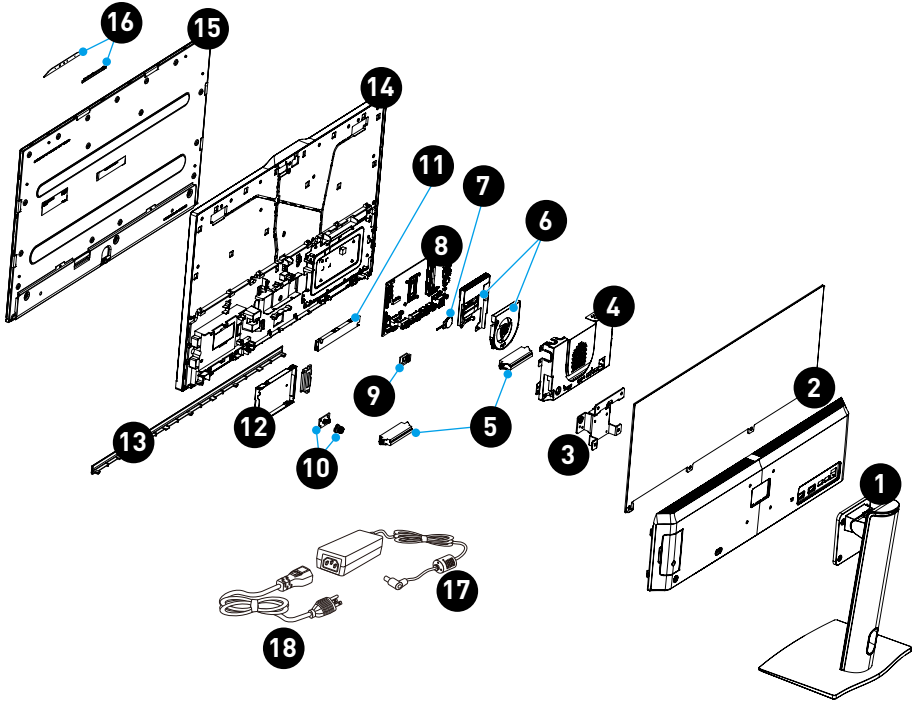

1. [Stand](#)
2. [Rear Cover & Panel Rear Cover](#)
3. [Stand Bracket](#)
4. [Mainboard Shield](#)
5. [Speakers](#)
6. [Fan & Thermal Module](#)
7. [Coin Battery](#)
8. [Mainboard](#)
9. [TPM Module](#)
10. [Navi Board & Navi Key](#)
11. [Converter Board](#)
12. [Hard Drive Tray](#)
13. [Deco Strip](#)
14. [LCD Bezel](#)
15. [LCD Panel](#)
16. [Webcam Module](#)
17. [External Power Supply](#)
18. Power Cord

Product Upgradeability and Repairability

Hardware features for upgradeable, repairable or replaceable using only commonly available tools and listing of replaceable spare parts by products can be obtained by contacting [MSI Online Customer Service](#).

For replacement, repair, or upgrade methods, please refer to the [hyperlinks](#) in the table below.

Hardware feature items	Upgradeable	Repairable	Replaceable	Soldering
The main processor(s) or system on a chip (SOC)	No	No	No	Yes
The main memory capacity of the system	No	No	Yes	No
Mass storage capacity of the system	Yes	No	Yes	No
Wireless networking capability	No	No	Yes	No
Graphics capability (integrated or discrete)	No	No	No	Yes
Display panel or display assembly	No	No	Yes	No
Integrated mechanical keyboards	N/A	N/A	N/A	N/A
All batteries	No	No	Yes	No
All external and internal power supplies	No	No	Yes	No
All fan assemblies	No	No	Yes	No
AND At least two of the following (or one, if all remaining are absent from product):	Upgradeable	Repairable	Replaceable	Soldering
Speakers	No	No	Yes	No
Camera	No	No	Yes	No
Touchpad	N/A	N/A	N/A	N/A
I/O connectors and external power connection	No	No	No	Yes
Readers (eg. magnetic stripe, Dallas key, fingerprint, Smart card)	N/A	N/A	N/A	N/A

Recommended Tools

The following tools may be needed while performing the disassembly and assembly procedures.

- Cross-head screwdriver
- Parallel screwdriver
- Tweezers
- Pry tool
- Diagonal pliers (optional)
- Heat gun (optional)
- Anti-static gloves
- Anti-static wrist strap (optional)
- Anti-static mat with grounding wire (optional)

Screw List

Please refer to the screw list below while proceeding the disassembly and assembly of the computer.

Note: This screw list is for reference only and may vary from models to models. It is highly recommended that users contact the authorized service center for further assistance.

Component	Screw Type	Quantity
Stand	M4*13.5	4
Rear Cover	M3*4	4
	M3*15	1
Panel Rear Cover	M3*4	4
Stand Bracket	M3*5	4
	B3*7	3
Mainboard Shield	M3*5	5
	#4-40	2
Speakers	B2.5*5.2	4
FAN	M2.5*4	2
Thermal Module	M2.5*4	4
SSD	M2*3	1
Wireless Card	M2*3	1
Mainboard	M3*5	3
Navi Board	B3*7	2
Converter Board	B3*7	2
SATA Cable	M3*3.5+4.8	2
Deco Strip	B2.5*5.4	5
LCD Bezel	M3*3	15
Middle Bracket	M3*5	3
DC-In Cable	B3*7	2

Preparation for Disassembly

1. Power off the PC.
2. Disconnect the power cord from the electrical outlet.
3. Disconnect the power cord from the PC.

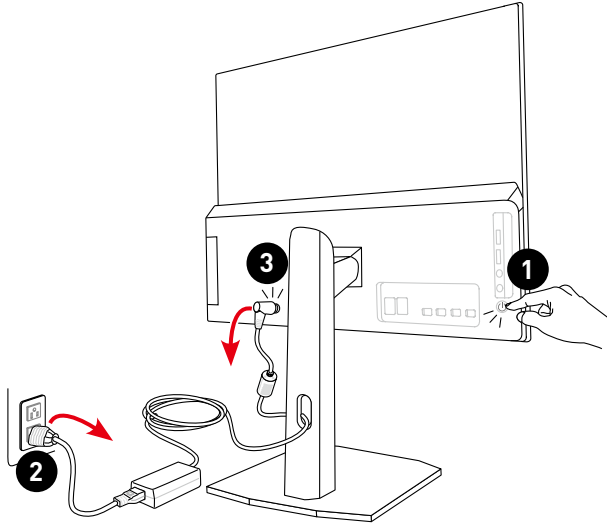

Important

- *Disconnect all power sources and place the PC on a steady surface before disassembly/assembly.*
- *When unplugging the power cord, always hold the connector part of the cord. Never pull the cord directly.*
- *Do not place the PC in environments subject to mist, smoke, vibration, excessive dust, salty or greasy air, or other corrosive gases and fumes.*
- *To avoid electrostatic discharge, use anti-static gloves or an anti-static wrist strap before handling electrostatic-sensitive components.*
- *Handle the display panel with extra care as it is fragile and could break.*
- *Do not perform any maintenance with wet hands.*
- *After assembly, ensure that all screws are replaced and no stray screws remain inside the PC.*

Stand

Stand Disassembly

1. Place the PC on a steady, protected surface.
2. Locate and remove the screws **1** that secure the stand with a cross-head screwdriver.
3. Lift the stand **2** off the rear cover.

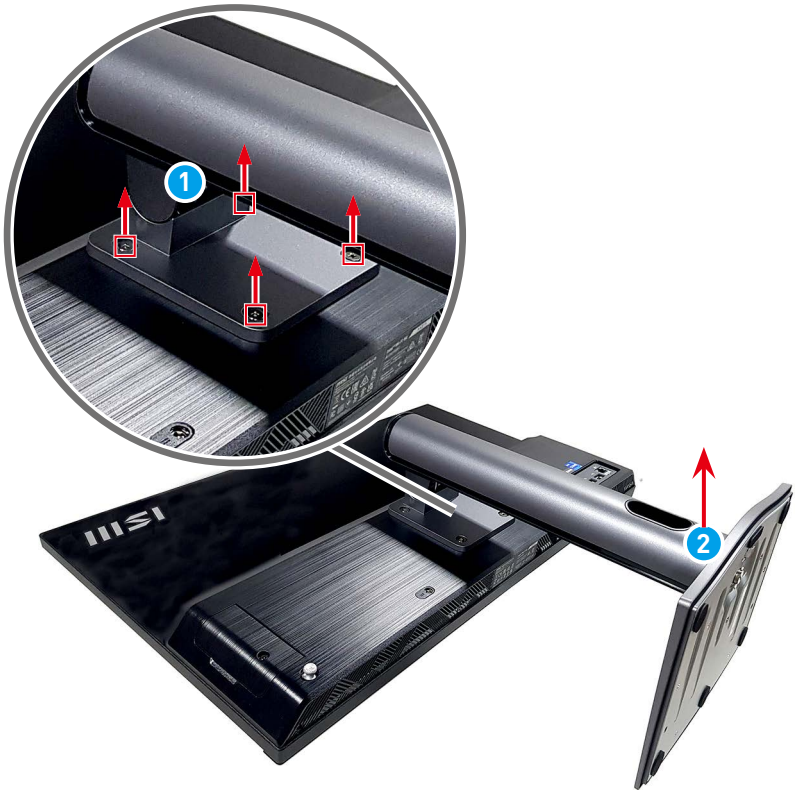

Stand Assembly

1. Place the stand **1** atop the rear cover groove with screw holes aligned.
2. Tighten the screws **2** with a cross-head screwdriver to secure the stand.



Rear Cover & Panel Rear Cover

Rear Cover & Panel Rear Cover Disassembly

1. Locate and remove the screws **1** that secure the rear cover with a cross-head screwdriver. Press inwards from the left and right sides of the rear cover **2** to disengage the cover hooks and lift the rear cover **2** off the computer.
2. Locate and remove the screws **3** that secure the panel rear cover with a cross-head screwdriver. Remove the panel rear cover **4** to uncover the computer components.

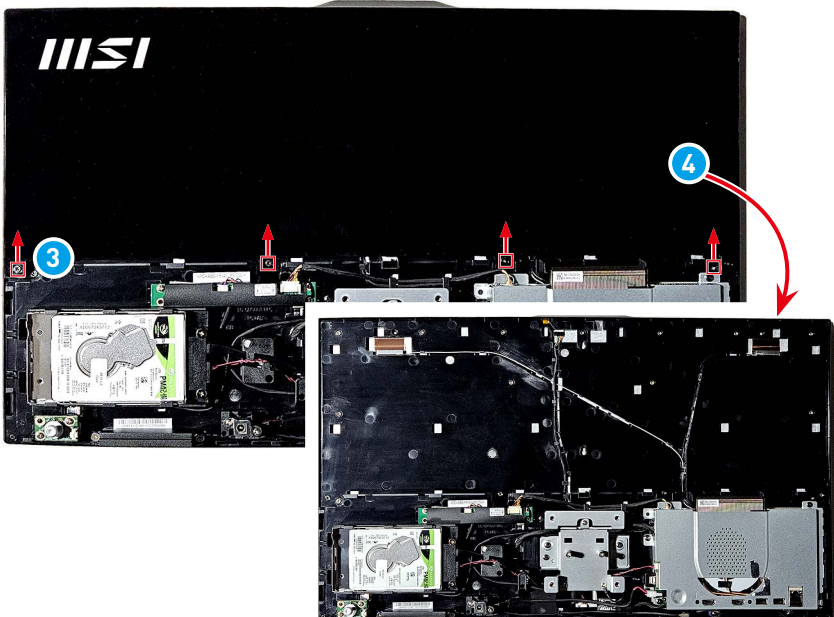
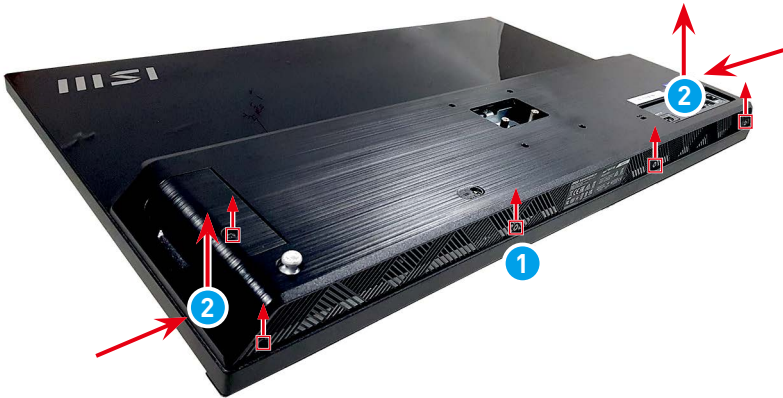

Rear Cover & Panel Rear Cover Assembly

1. Place the panel rear cover **1** on the upper part of the LCD bezel with screw holes aligned. Tighten the screws **2** with a cross-head screwdriver to secure the panel rear cover in place.
2. Place the rear cover **3** on the lower part of the LCD bezel with screw holes aligned. Tighten the screws **4** with a cross-head screwdriver to secure the rear cover in place.

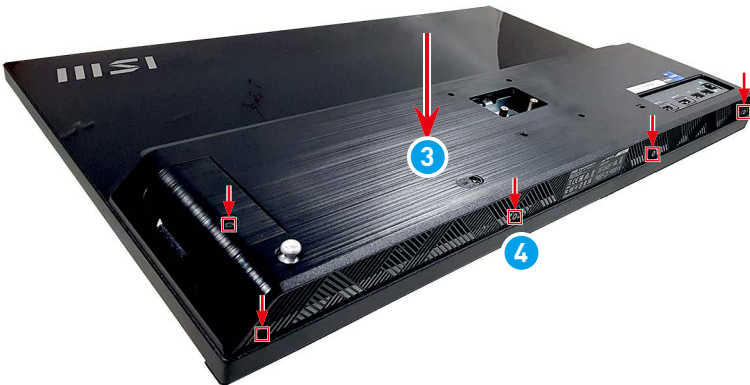
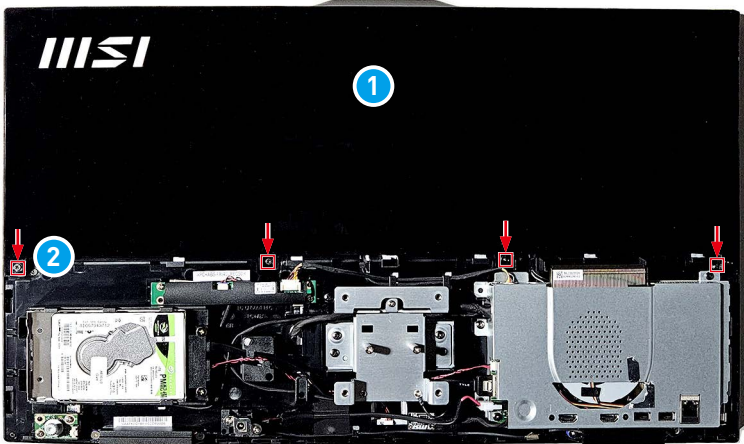

Stand Bracket

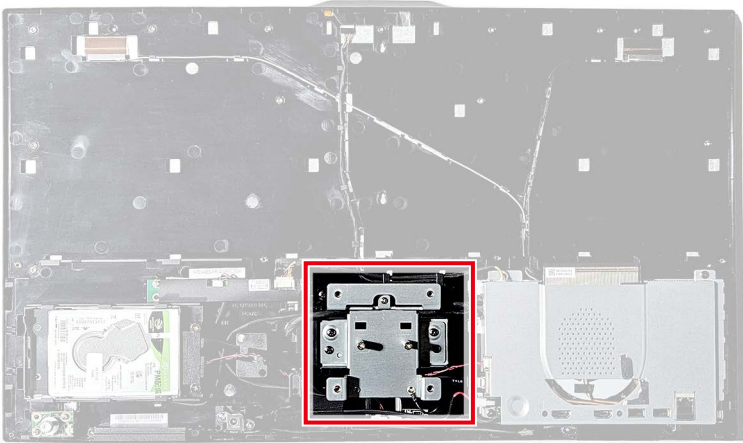

Stand Bracket Disassembly

1. Locate and remove the screws **1** that secure the stand bracket with a cross-head screwdriver.
2. Remove the stand bracket **2** from the LCD bezel.

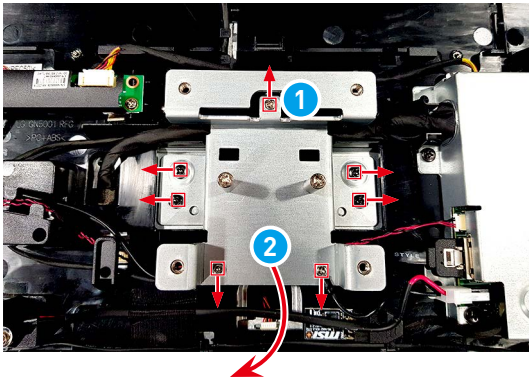

Stand Bracket Assembly

1. Place the stand bracket **1** atop the LCD bezel with screw holes aligned.
2. Tighten the screws **2** with a cross-head screwdriver to secure the stand bracket in place.

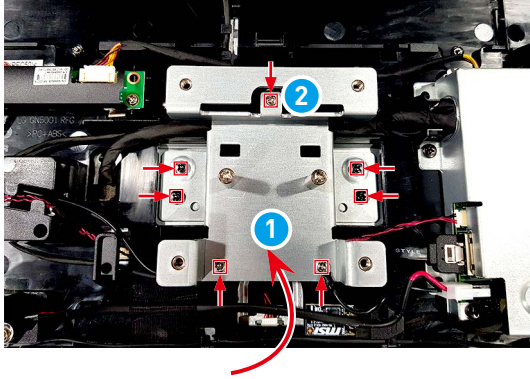

Mainboard Shield

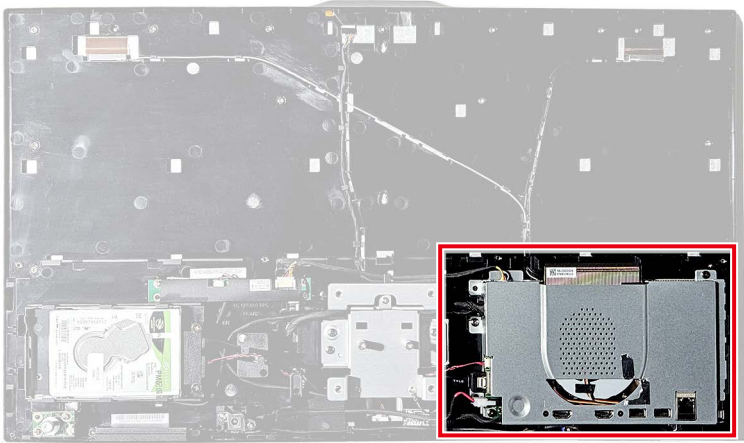

Mainboard Shield Disassembly

1. Locate and disconnect the SATA power cable ①, SATA data cable ②, DC-in cable ③, and TPM module cable ④.
2. Locate and remove the screws ⑤ that secure the mainboard shield with a cross-head screwdriver.
3. Lift the mainboard shield ⑥ up to uncover the mainboard.

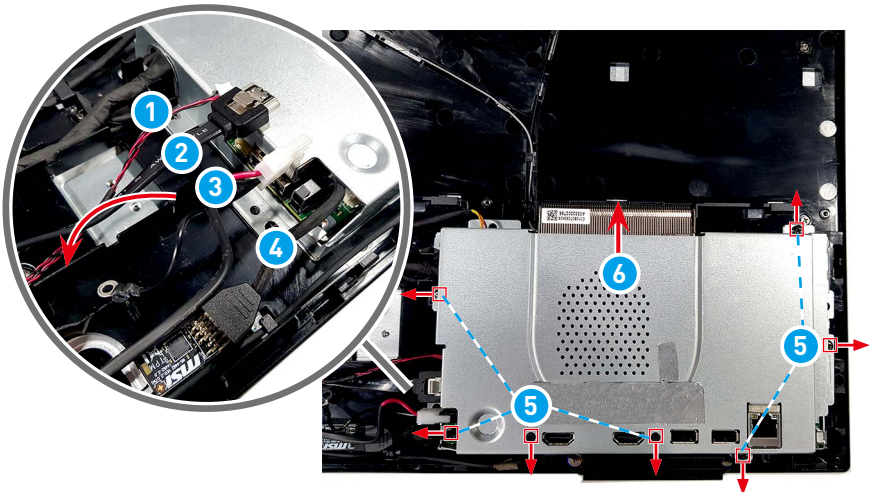

Mainboard Shield Assembly

1. Place the mainboard shield **1** atop the mainboard with screw holes aligned.
2. Tighten the screws **2** with a cross-head screwdriver to secure the mainboard shield in place.
3. Connect the SATA power cable **3**, SATA data cable **4**, DC-in cable **5**, and TPM module cable **6**.

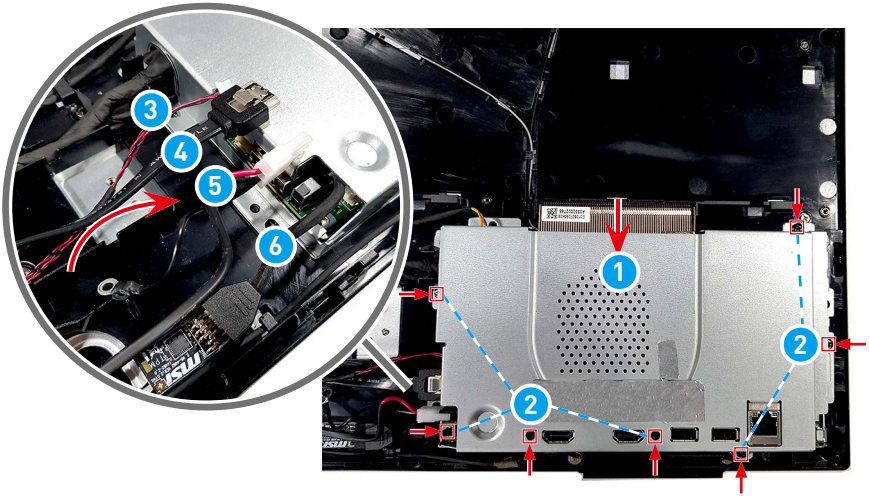

Speakers

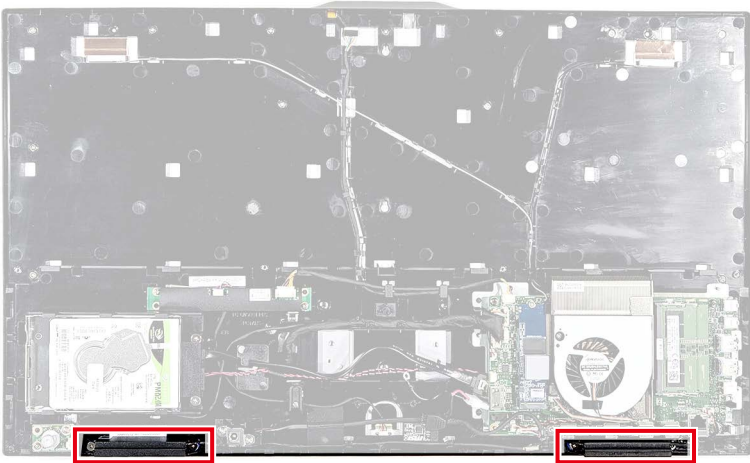

Speaker Disassembly

1. Disconnect the speaker cable **1** from the mainboard.
2. Remove the screws **2** that secure the speakers with a cross-head screwdriver.
3. Lift the speakers **3** along with the cable off the LCD bezel.

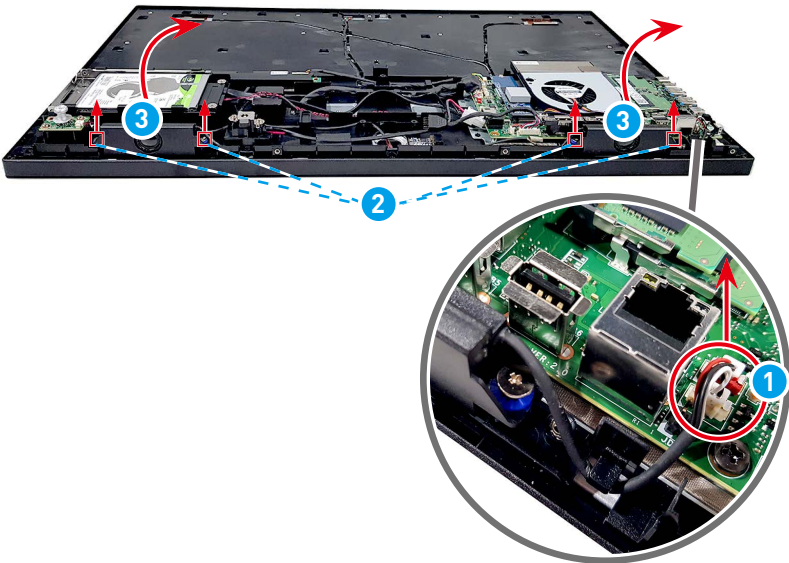

Speaker Assembly

1. Replace and align the speakers **1** to the screw holes on the LCD bezel.
2. Replace and tighten the screws **2** with a cross-head screwdriver to secure the speakers in place.
3. Route the speaker cable **3** and connect it to the mainboard.

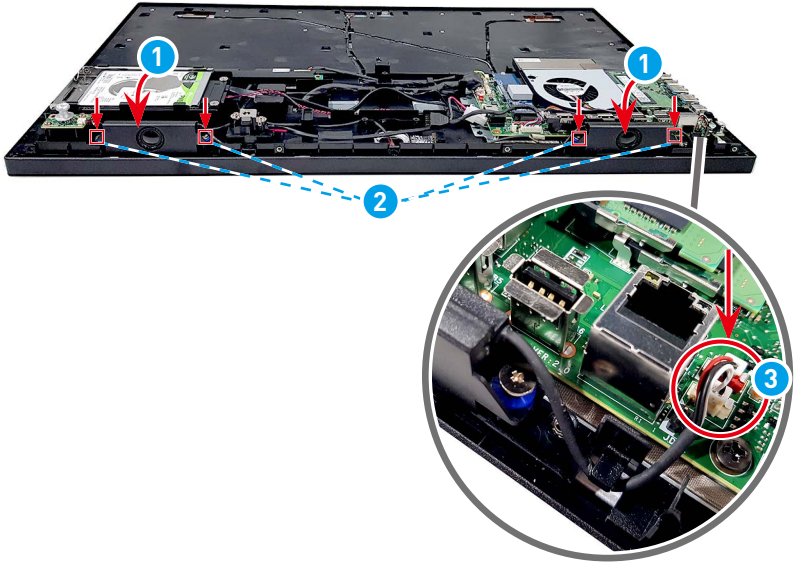

Fan & Thermal Module

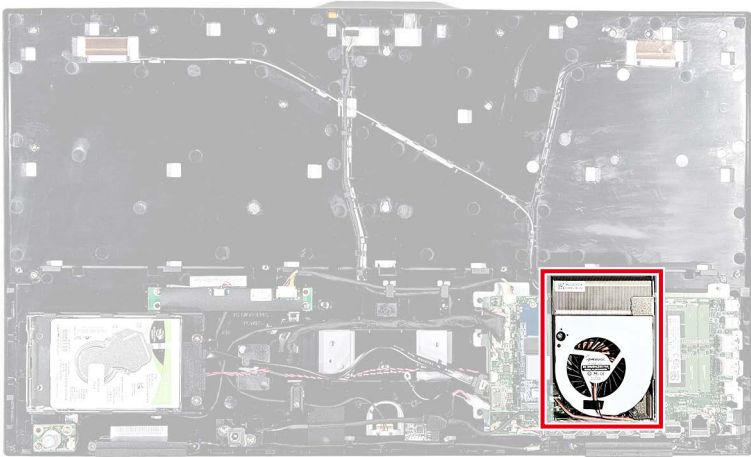

Fan & Thermal Module Disassembly

1. Disconnect the fan cable **1** from the mainboard.
2. Remove the screws **2** that secure the fan with a cross-head screwdriver.
3. Lift the fan **3** and its cable off the mainboard.
4. Remove the screws **4** that secure the thermal module with a cross-head screwdriver.
5. Lift the thermal module **5** off the mainboard.

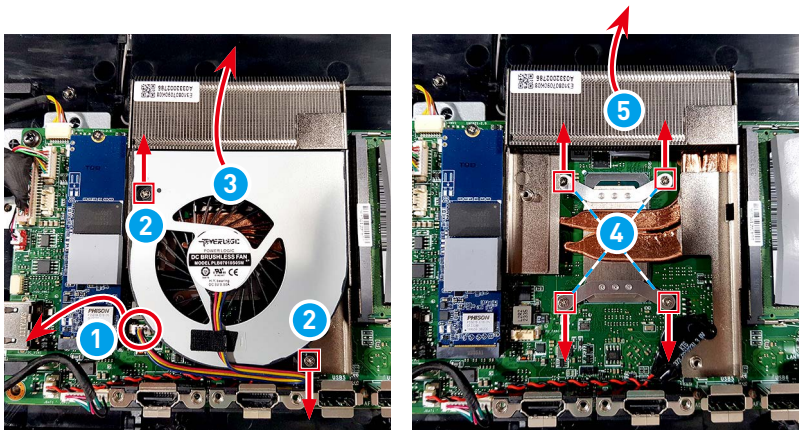

Fan & Thermal Module Assembly

1. Place the thermal module **1** atop the CPU with screw holes aligned.
2. Replace and tighten the screws **2** with a cross-head screwdriver to secure the thermal module in place.
3. Place the fan **3** atop the thermal module with screw holes aligned.
4. Replace and tighten the screws **4** with a cross-head screwdriver to secure the fan in place.
5. Connect the fan cable **5** to the mainboard.

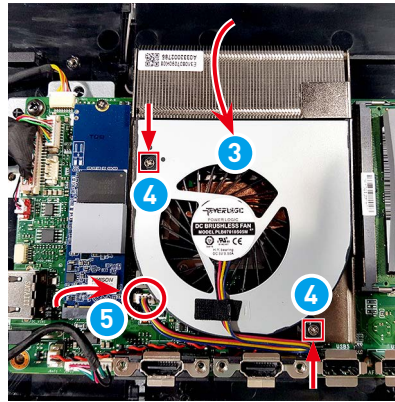
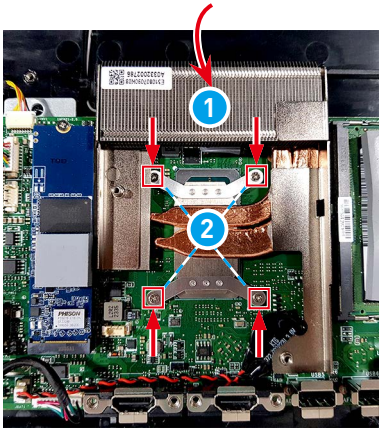

Memory Module

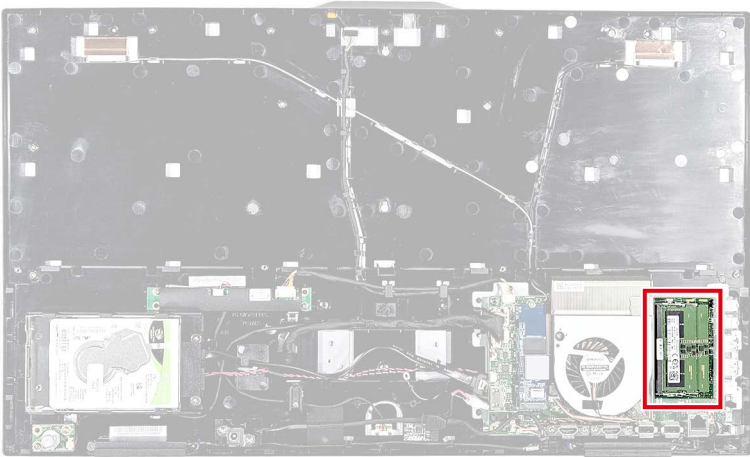

Memory Module Disassembly

1. Spread apart the slot clips **1** on the memory module slot until the memory module pops up.
2. Slide and remove the memory module **2** from the slot.
3. Repeat the steps if there are more memory modules **2**.

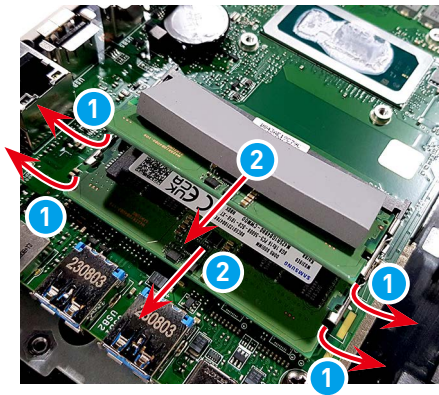

Memory Module Assembly

1. Align the notch on the memory module with the key on the slot and insert the memory module **1** into the slot.
2. Push the memory module gently downwards until the slot clips **2** click and lock the memory module in place.
3. Repeat the steps if there are more memory modules **1**.

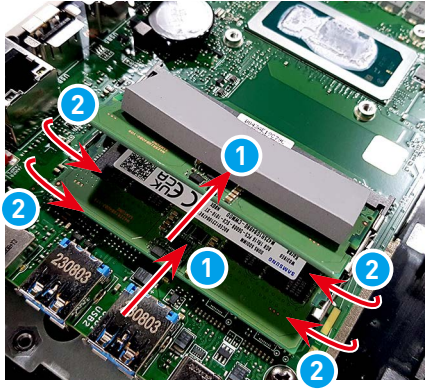

Solid State Drive



Solid-State Drive Disassembly

1. Remove the screw **1** that secures the solid-state drive with a cross-head screwdriver.
2. Slide and remove the solid-state drive **2** from the M.2 slot.

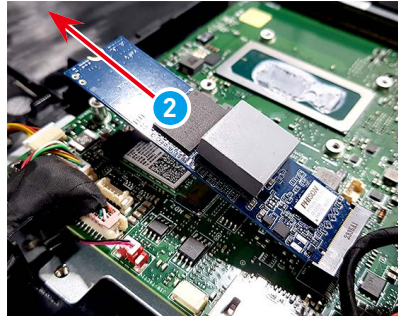
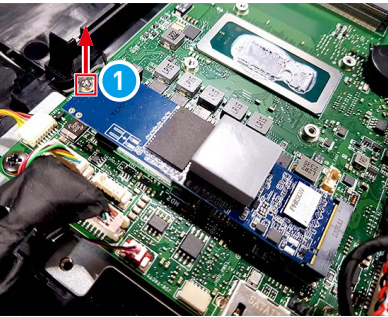

Solid-State Drive Assembly

1. Align the notch on the solid-state drive with the tab on the M.2 slot.
2. Slide the solid-state drive **1** into the M.2 slot.
3. Replace and tighten the screw **2** with a cross-head screwdriver to secure the solid-state drive in place.

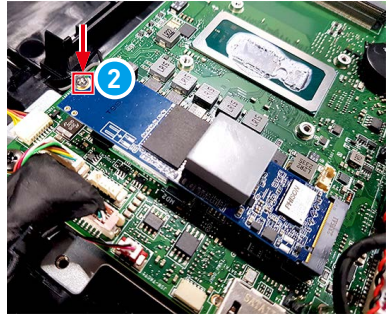
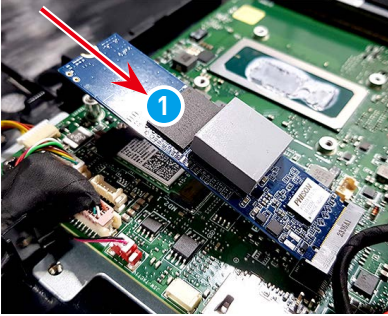

Wireless Card

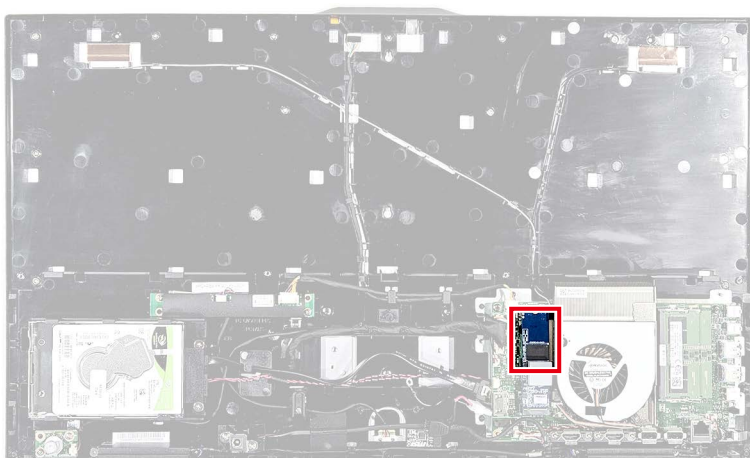

Wireless Card Disassembly

1. Follow [Solid-State Drive Disassembly](#) to remove the SSD and uncover the wireless card underneath.
2. Locate and remove the wireless card clip **1** and remove the screw **2** that secures the wireless card with a cross-head screwdriver.
3. Disconnect the antenna cables **3**.
4. Remove the wireless card **4** from the card slot.

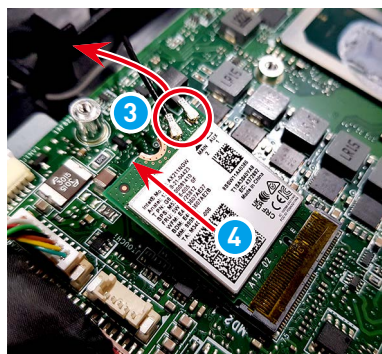
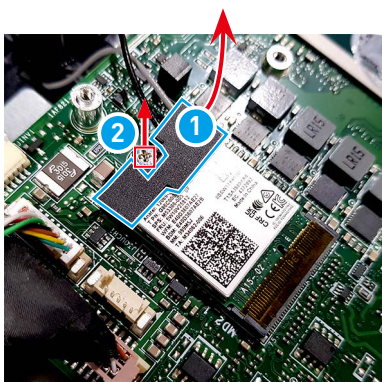

Wireless Card Assembly

1. Align the notch on the wireless card with the key on the slot, and insert the wireless card **1** into the slot.
2. Connect the antenna cables **2** to the wireless card.
3. Gently push the wireless card downwards and use a cross-head screwdriver to secure the card with the screw **3**.
4. Replace and secure the wireless card clip **4** onto the wireless card.

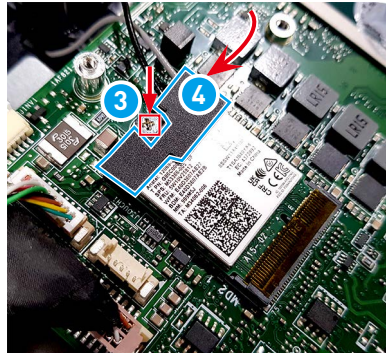
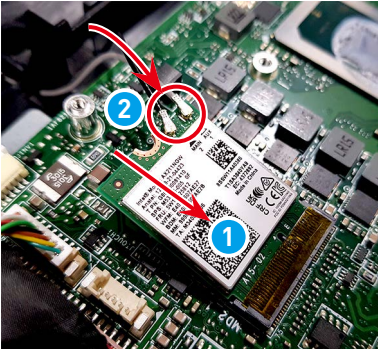

Coin Battery



Important

- *Danger of explosion if battery is incorrectly replaced. Replace only with the same or equivalent type recommended by the manufacturer.*
- *Avoid disposal of a battery into fire or a hot oven, or mechanically crushing or cutting of a battery, which can result in an explosion.*
- *Avoid leaving a battery in an extremely high temperature or extremely low air pressure environment that can result in an explosion or the leakage of flammable liquid or gas.*
- *Do not ingest battery. If the coin/button cell battery is swallowed, it can cause severe internal burns and can lead to death. Keep new and used batteries away from children.*

Coin Battery Disassembly

1. Follow [Fan & Thermal Module Disassembly](#) to remove the fan and thermal module and uncover the coin battery underneath.
1. Locate and disconnect the coin battery cable **1**.
2. Use your fingers to grab the edge of the coin battery **2** and gently pull it off. Remove the coin battery along with its cable from the mainboard.

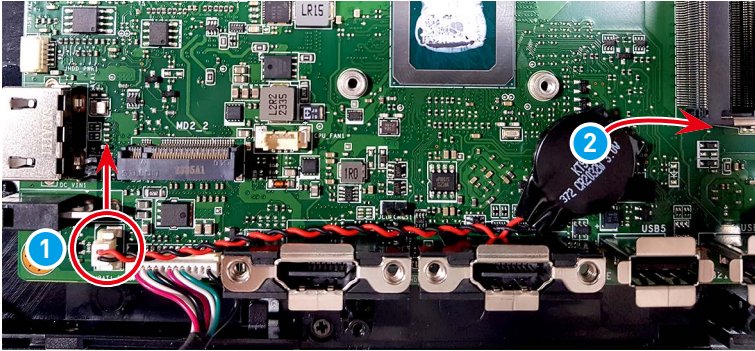

Coin Battery Assembly

1. Replace the coin battery **1** and secure it with its adhesive tape.
2. Connect the coin battery cable **2**.

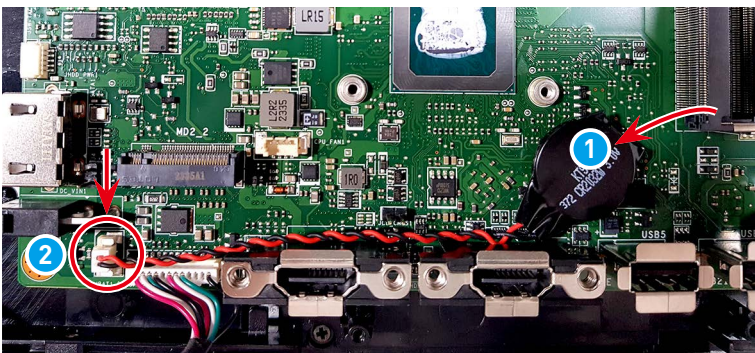

Mainboard



Mainboard Disassembly

1. After disassembling the fan, thermal module and all onboard components, disconnect the converter board cable **1**, webcam cable **2**, LVDS cable **3**, Navi board cable **4**, and TPM cable **5** from the mainboard.
2. Remove the screws **6** that secure the mainboard with a cross-head screwdriver.
3. Lift and remove the mainboard **7** from the LCD bezel.

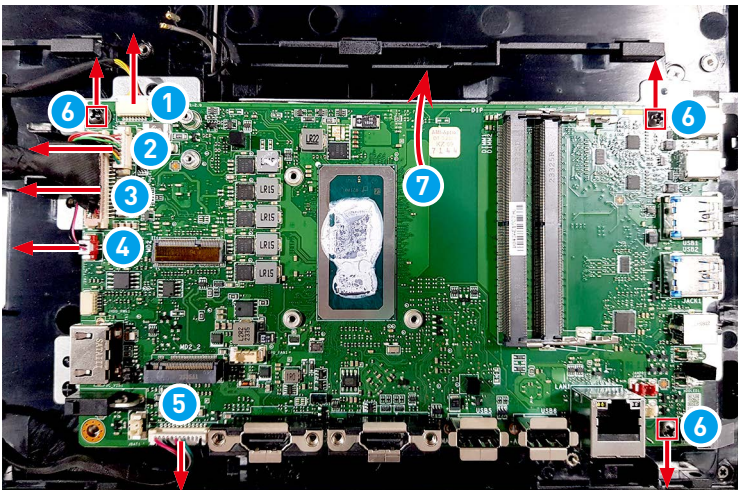

Mainboard Assembly

1. Place the mainboard **1** atop the LCD bezel with screw holes aligned.
2. Replace and tighten the screws **2** with a cross-head screwdriver to secure the mainboard in place.
3. Connect the converter board cable **3**, webcam cable **4**, LVDS cable **5**, Navi board cable **6**, and TPM cable **7** to the mainboard.

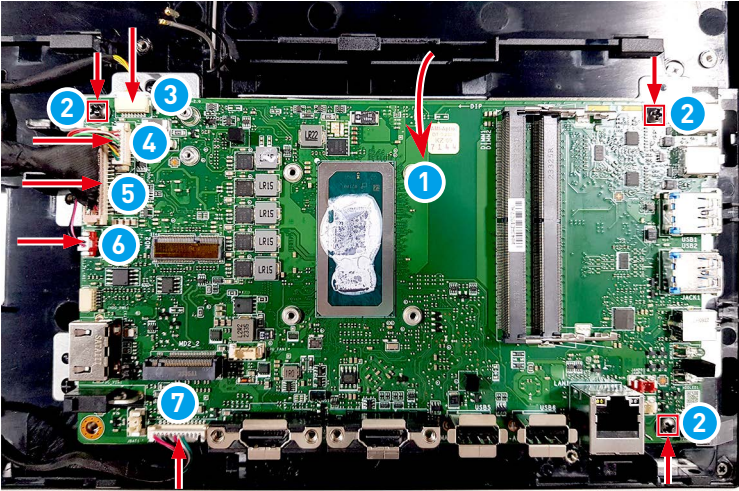

TPM Module



TPM Module Disassembly

1. Locate and disconnect the TPM module cable **1**.
2. Use your fingers to grab the edge of the TPM module **2** and gently pull it off the LCD bezel.

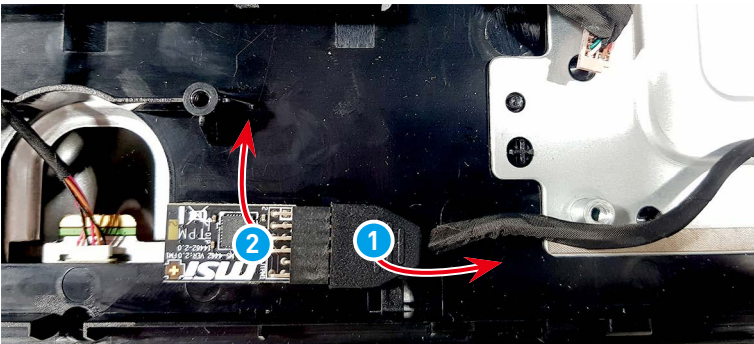

TPM Module Assembly

1. Place the TPM module **1** onto the LCD bezel and secure the module with its adhesive tape underneath.
2. Connect the TPM module cable **2**.

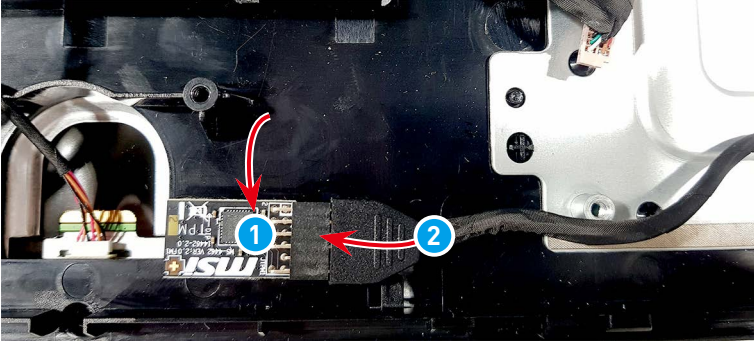

Navi Board

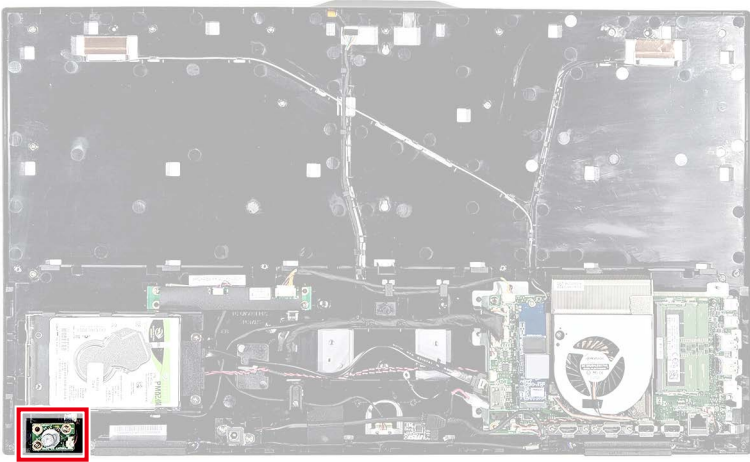

Navi Board Disassembly

1. Check the LCD bezel and locate the Navi board. Remove the screws **1** that secure the Navi board with a cross-head screwdriver.
2. Lift the Navi board **2** off the LCD bezel.

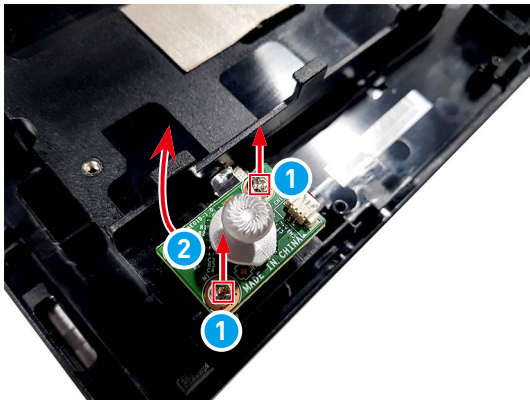

Navi Board Assembly

1. Place the Navi board **1** atop the LCD bezel with screw holes aligned.
2. Replace and tighten the screws **2** with a cross-head screwdriver to secure the Navi board in place.

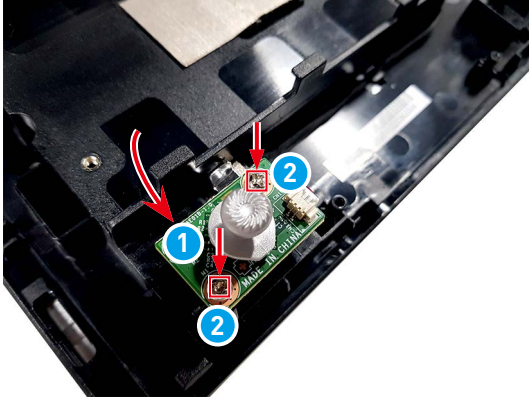

Converter Board

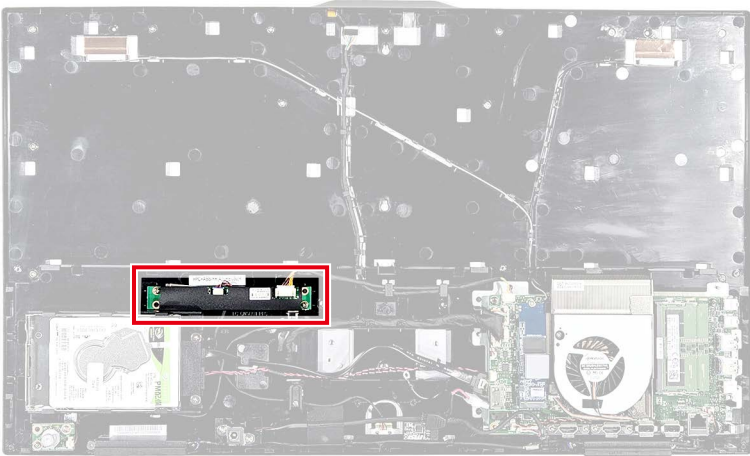

Converter Board Disassembly

1. Locate and disconnect the converter board cables **1**.
2. Locate and remove the screws **2** that secure the converter board with a cross-head screwdriver.
3. Lift and remove the converter board **3** from the LCD bezel.

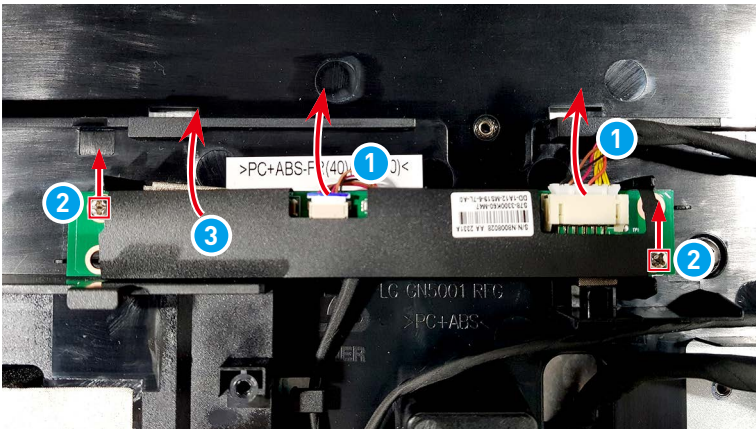

Converter Board Assembly

1. Place the converter board **1** atop the LCD bezel with screw holes aligned.
2. Replace and tighten the screws **2** with a cross-head screwdriver to secure the converter board in place.
3. Connect the converter board cables **3**.

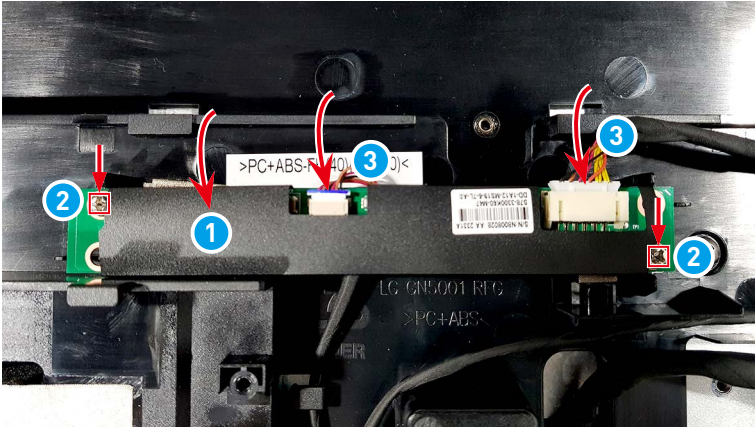

Hard Drive (Optional)

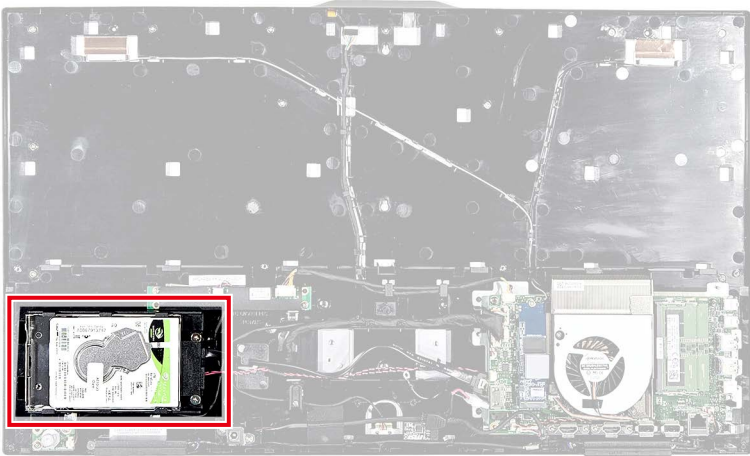

Hard Drive Disassembly

1. Disconnect the SATA cables **1** from the mainboard.
2. Locate and remove the SATA cable screws **2** with a cross-head screwdriver.
3. Gently slide to remove the hard drive assembly **3**.
4. Remove the hard drive screws **4** on both sides of the tray to release the hard drive.

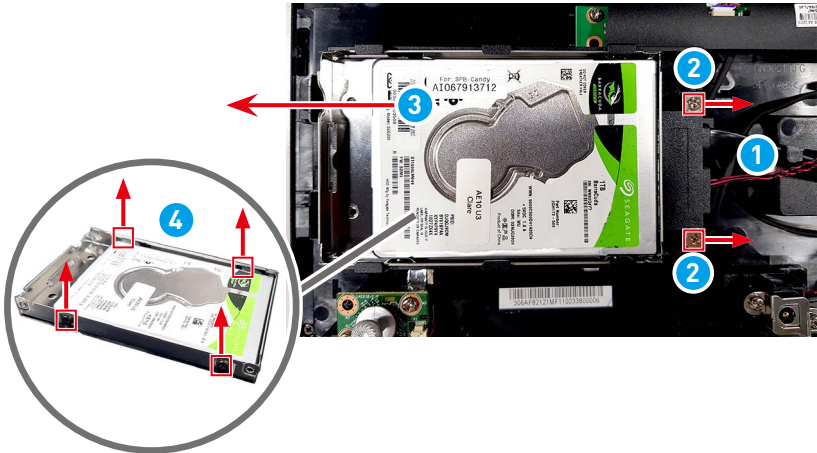

Hard Drive Assembly

1. Fit the hard drive into the tray and tighten the screws **1** on both sides of the tray to secure the hard drive in place.
2. Tighten the SATA cable screws **2** with a cross-head screwdriver.
3. Gently slide and push the hard drive assembly **3** back in place.
4. Connect the SATA cables **4** to the mainboard.

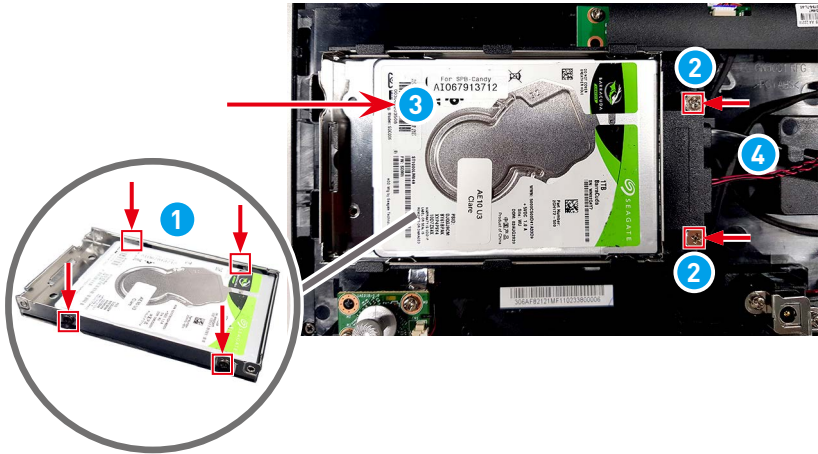

Deco Strip

Deco Strip Disassembly

1. Remove the screws **1** that secure the deco strip to the LCD bezel with a cross-head screwdriver.
2. Gently pull outwards to remove the deco strip **2** from the LCD bezel.

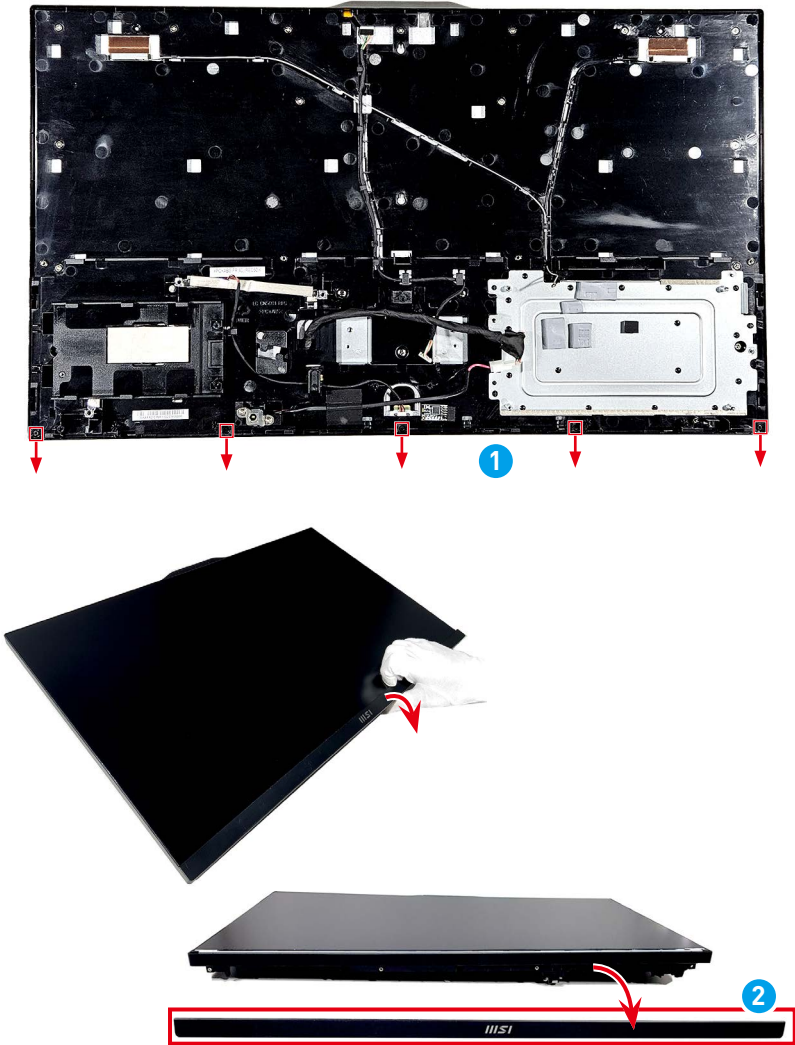

Deco Strip Assembly

1. Place the deco strip **1** back to the LCD bezel with screw holes aligned and then snap it into place by pressing down around the edges.
2. Replace and tighten the screws **2** with a cross-head screwdriver to secure the deco strip to the LCD bezel.

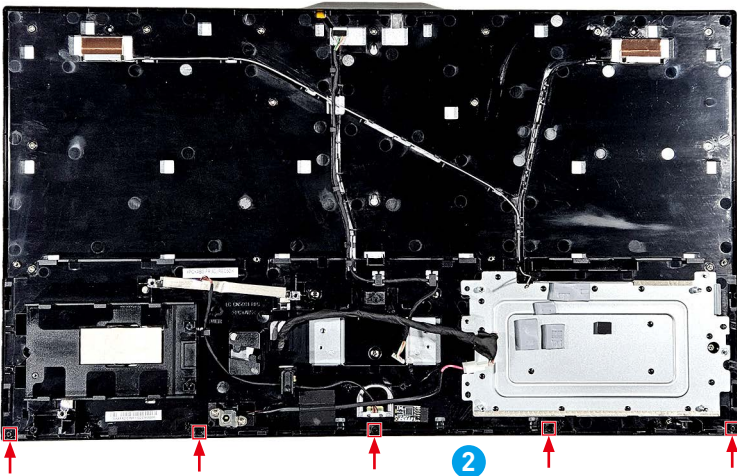

LCD Bezel & Panel

LCD Bezel & Panel Disassembly

1. Remove the screws **1** that secure the LCD bezel to the LCD panel with a cross-head screwdriver.
2. Remove the LCD panel **2** from the LCD bezel **3**.
3. Remove the antenna cables **4**, LVDS cable **5**, panel power cable **6**, and EMI gaskets **7** from the LCD panel.

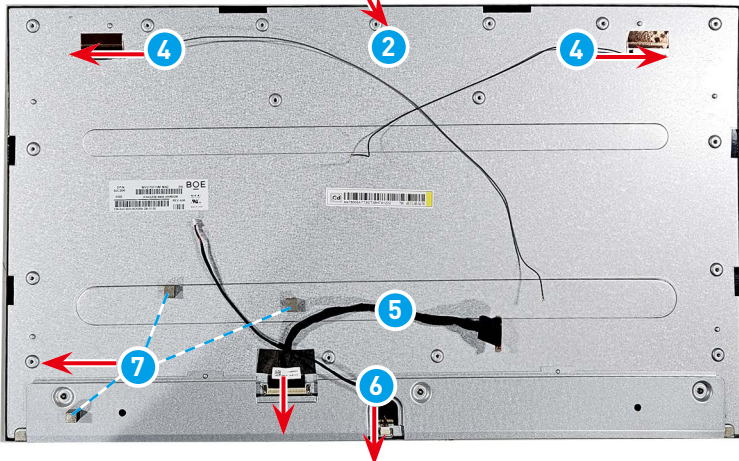
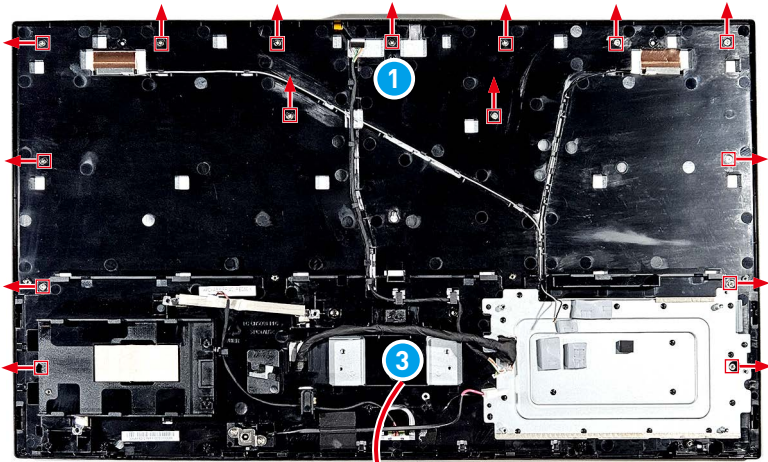

LCD Bezel & Panel Assembly

1. Put the antenna cables **1**, LVDS cable **2**, panel power cable **3**, and EMI gaskets **4** back to the LCD panel and secure them in place.
2. Place the LCD panel **5** atop the LCD bezel **6** with screw holes aligned.
3. Replace and tighten the screws **7** with a cross-head screwdriver to secure the LCD panel to the LCD bezel.

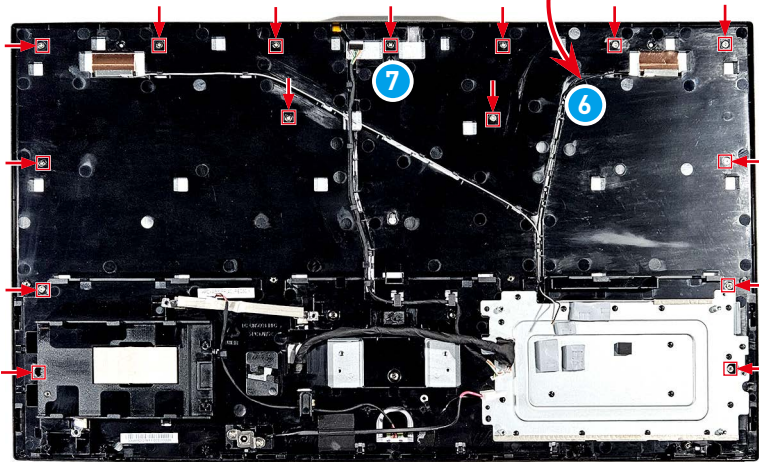
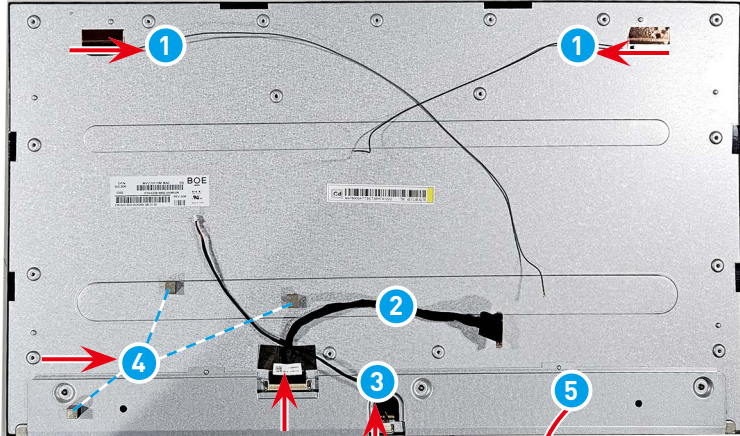

Webcam Module



Webcam Module Disassembly

1. Remove the top webcam mylar **1** and inner webcam mylar **2** from the LCD bezel.
2. Remove the webcam module **3** from the LCD bezel with tweezers.

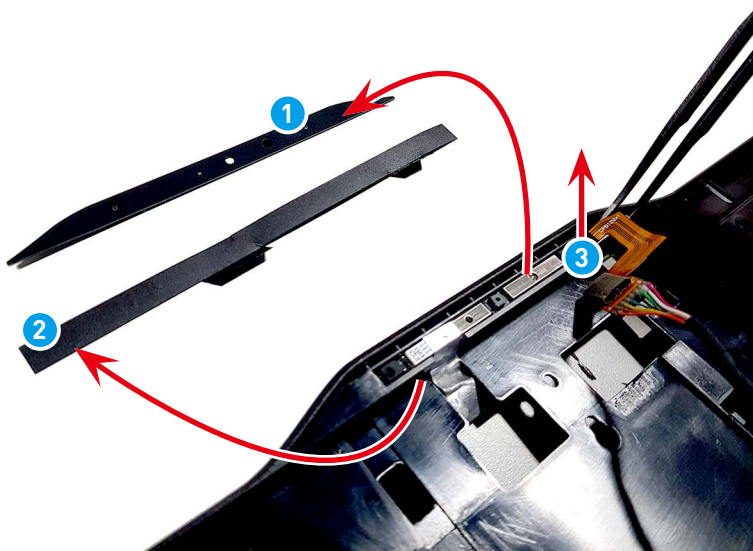

Webcam Module Assembly

1. Align and secure the webcam module **1** onto the LCD bezel with tweezers.
2. Replace and secure the top webcam mylar **2** and inner webcam mylar **3** to the LCD bezel.

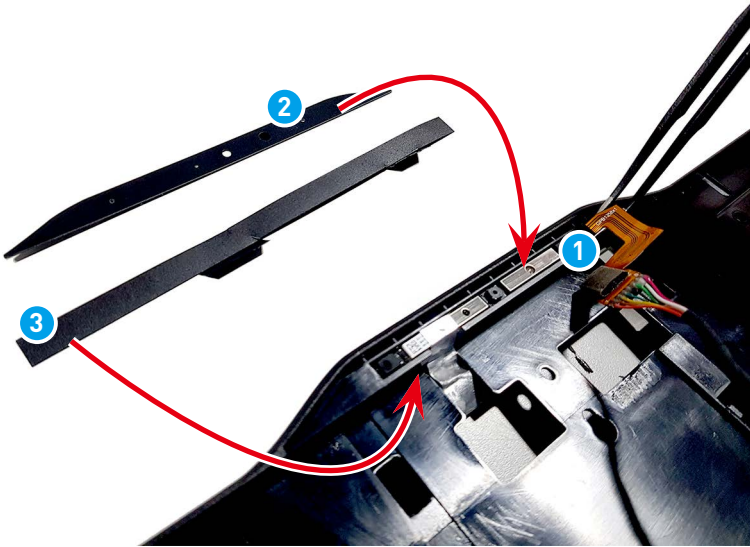

Powering Up After Maintenance

1. Assemble the external power supply & power cord.
2. Connect the external power supply to the PC.
3. Plug the power cord into the electrical outlet.
4. Power on the PC.

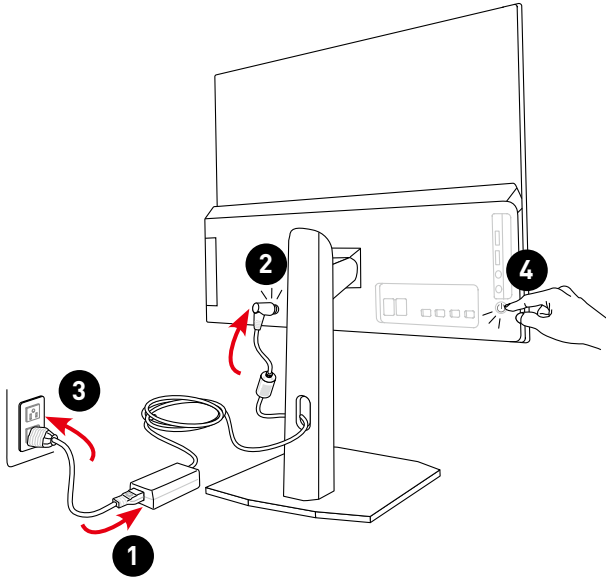

Important

- Use only the MSI provided AC adapter approved for use with this PC.
- If the power cord comes with a 3-pin plug, do not disable the protective earth pin from the plug. The PC must be connected to an earthed mains socket-outlet.
- Plug the power cord into an electrical outlet that is easily accessible at all times.
- Place the power cord in a way that people are unlikely to step on it. Do not place anything on the power cord.
- Always disconnect the power cord or switch the wall socket off if the PC would be left unused for a certain time to achieve zero energy consumption.

OSD Setup

This chapter provides you with essential information on OSD Setup.

Navi Key

The AIO comes with a Navi Key, a multi-directional control that helps navigate the On-Screen Display (OSD) menu.

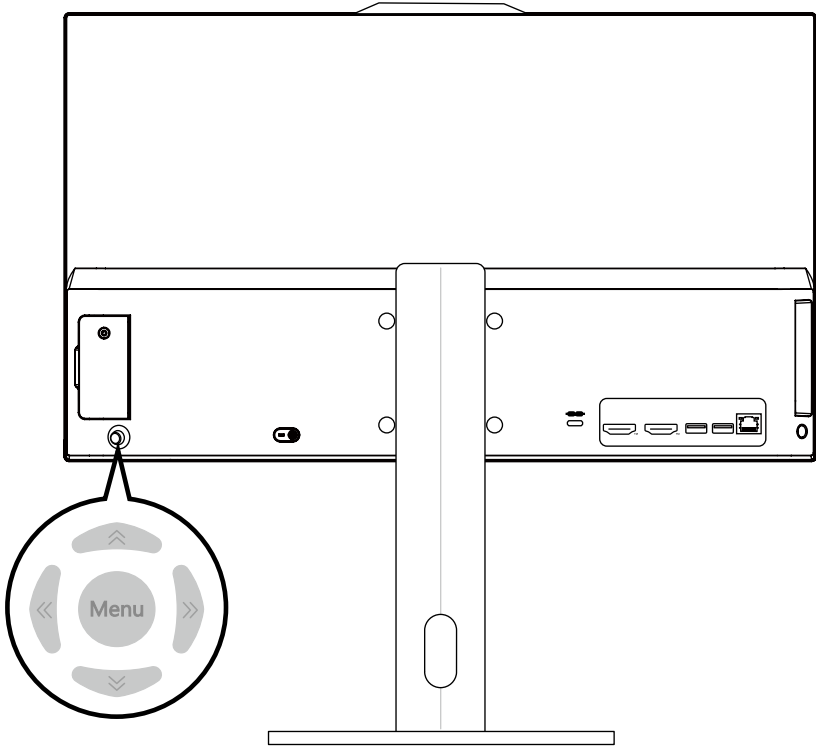

Up/Down/Left/Right:

- selecting function menus and items
- adjusting function values
- entering into/exiting from function menus

Press (Menu):

- launching the On-Screen Display (OSD)
- entering submenus
- confirming a selection or setting

Hot Key

- Users may enter into Volume, Brightness, Mode and Input Source function menus by moving the Navi Key up, down, left or right when the OSD menu is inactive.

OSD Setup via Navi Key

Press the Middle button of Navi Key to launch the On-Screen Display (OSD) main menu. Use the Up, Down, Left, Right buttons to tune the desired function menus to suit your personal preferences. Press Menu 3 seconds to shut the panel off. Press Menu again to wake it up.

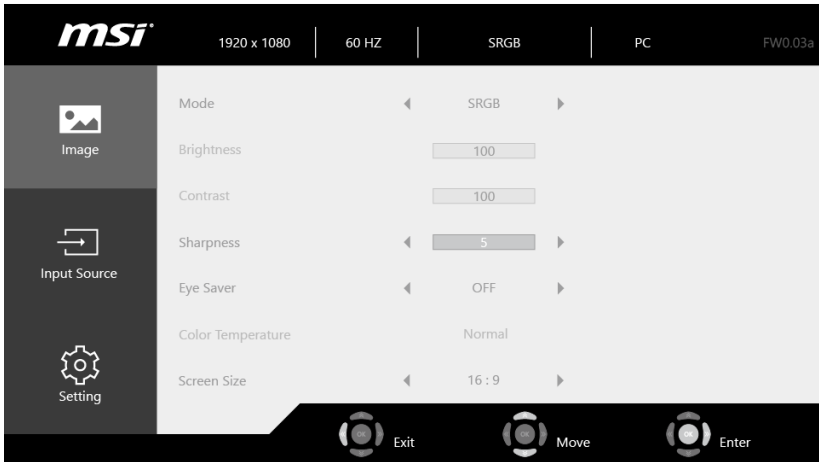

Image

1st Level Menu	2nd/ 3rd Level Menu	Description
Mode	User	<ul style="list-style-type: none"> Default is User. While sRGB mode is selected, the color space will be changed to standard sRGB from original panel gamut.
	Reader	
	Cinema	
	Designer	
	sRGB	
Brightness	0-100	<ul style="list-style-type: none"> Properly adjust Brightness according to the surrounding lighting. Brightness will be grayed out in PC Mode.
Contrast	0-100	<ul style="list-style-type: none"> Properly adjust Contrast to relax your eyes.
Sharpness	0-5	<ul style="list-style-type: none"> Sharpness improves clarity and details of images.
Eye Saver	OFF	<ul style="list-style-type: none"> Eye Saver has to be enabled in Reader Mode.
	ON	

1st Level Menu	2nd/ 3rd Level Menu	Description
Color Temperature	Cool	<ul style="list-style-type: none"> • Use Up or Down Button to select and preview mode effects. • Press the Menu Button to confirm and apply your mode type. • Color Temperature will be grayed out when sRGB mode is selected.
	Normal	
	Warm	
	Customization	
	R [0-100]	
	G [0-100]	
	B [0-100]	
Screen Size	4:3	<ul style="list-style-type: none"> • Users can adjust Screen Size in any mode, any resolution and any screen refresh rate.
	16:9	

Input Source

1st Level Menu	Description
PC	<ul style="list-style-type: none"> • User can use Navi Key and OSD Menu to adjust the Input Source in any Mode.
HDMI™	

Setting

1st Level Menu	2nd Level Menu	Description
Language	English	<ul style="list-style-type: none"> • Language is an independent setting. User's own language setting will override the factory default. When user sets Reset to Yes, Language will not be changed.
	繁體中文	
	简体中文	
	Italiano	
	Español	
	Français	
	Português	
	Deutsch	
	日本語	
Русский		
Transparency	0-5	<ul style="list-style-type: none"> • Users can adjust Transparency in any mode.
OSD Time Out	5-30	<ul style="list-style-type: none"> • Users can adjust OSD Time Out in any mode.
Audio Volume	0-100	<ul style="list-style-type: none"> • Users can adjust Audio Volume in any mode.
Reset	YES	<ul style="list-style-type: none"> • Users can Reset and restore settings to original OSD Default in any mode.
	NO	

Troubleshooting

Users may refer to the following tips or visit [MSI Support](#) and [Troubleshooting](#) for quick and easy troubleshooting when encountering common problems with the product. It is always suggested that users contact the authorized MSI service center for advanced tech support if needed.

My system does not start.

- Check if the system is connected to an electrical outlet and it is turned on.
- Check if the power cord and all cables are connected firmly.

When I turn on my computer, the message “Operating System not found” appears or Windows does not start.

- Check if there is a non-bootable CD/ DVD inside the optical disk drive. If so, remove the CD/ DVD then restart the computer.
- Check Boot Device Priority settings in the BIOS Setup.

The system can not be shut down.

It is best to shut down your computer using the Shut Down icon in the operating system. Using other methods, including those listed below, may result in data failure. If the Shut Down procedure does not work, choose one of the following steps:

- Press Ctrl+Alt+Del keys, then choose Shut Down.
- Press and hold the power button till the system is off.
- Unplug the power cable from the system.

My microphone does not work.

- For built-in microphone, please go to Start > Control Panel > Sounds and Audio Devices > Audio to check if it is muted.
- If you are using an external microphone, check that the microphone is plugged into the Microphone jack.

The Internet connection has problems.

- If you are having a problem connecting to your Internet Service Provider (ISP), check if the ISP is experiencing technical problems.
- Check the Network settings and connection and make sure the system is properly configured to Internet access.
- The wireless LAN data transfer speed is affected by distance and obstructions between devices and access points. To maximize the data transfer speed, choose the access point closest to your system.

System speakers do not work.

- Check the master volume setting in the Audio Mixer.
- If you are using an application that has its own volume control, check if the volume is muted.
- If you have connected an audio cable to the Headphone jack, disconnect it.
- If the system has OSD function, please adjust the volume of OSD.

System monitor does not display anything.

- Check if the system is connected to an electrical outlet and it is turned on.
- The system may be in Standby mode. Press any key to activate the Display.

Recycling Guidelines

In line with our commitment to environmental sustainability, this product is designed with separable plastic components to enhance plastic recycling quality. We kindly request that you responsibly recycle the recyclable plastic components of this product once it reaches the end of its useful life. Follow the instructions below to prepare plastic parts for recycling by eliminating non-recyclable materials.

Important

Before recycling the separable plastic components, please use diagonal pliers or a cross-head screwdriver to remove all the screw bosses with copper sticks, if any.

Stand

1. Follow [Stand Disassembly](#) to remove the stand from the computer.
2. Locate and remove the screws **1** that secure the VESA plate with a cross-head screwdriver and remove the VESA plate **2** from the stand.
3. To disassemble the VESA plate, pry around its edges with a parallel screwdriver until the recyclable plastic VESA plate **3** and the metal VESA plate **4** are separated.



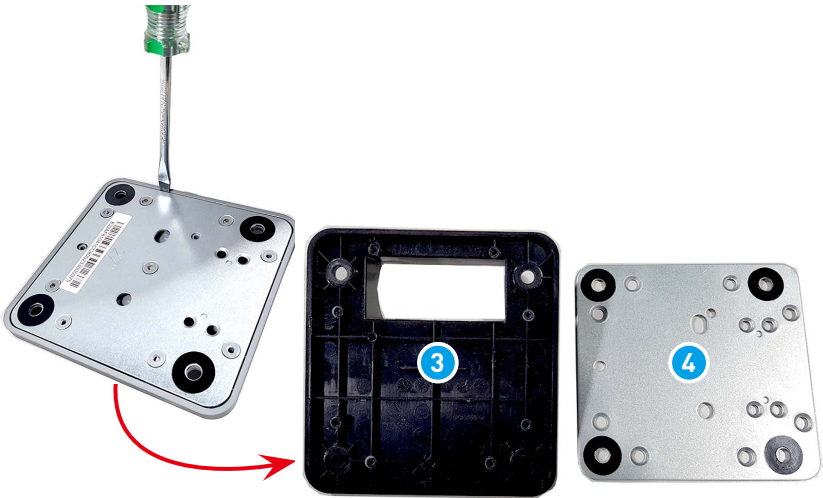

4. Turn the thumbscrew **5** counterclockwise to unlock and remove the base from the stand.
5. Remove the rubber feet **6** to uncover the base screws.
6. Remove the base screws **7** with a cross-head screwdriver to separate the recyclable plastic base plate **8** from the metal base plate **9**.



-
7. Locate and remove the screw **10** that secures the hinge cover with a cross-head screwdriver and remove the hinge cover **11** and E-cover **12** from the stand.
 8. To disassemble the stand's front cover **13** and rear cover **14**, pry around the stand's edges with a pry tool until the recyclable front cover and rear cover are separated from the metal stand **15**.

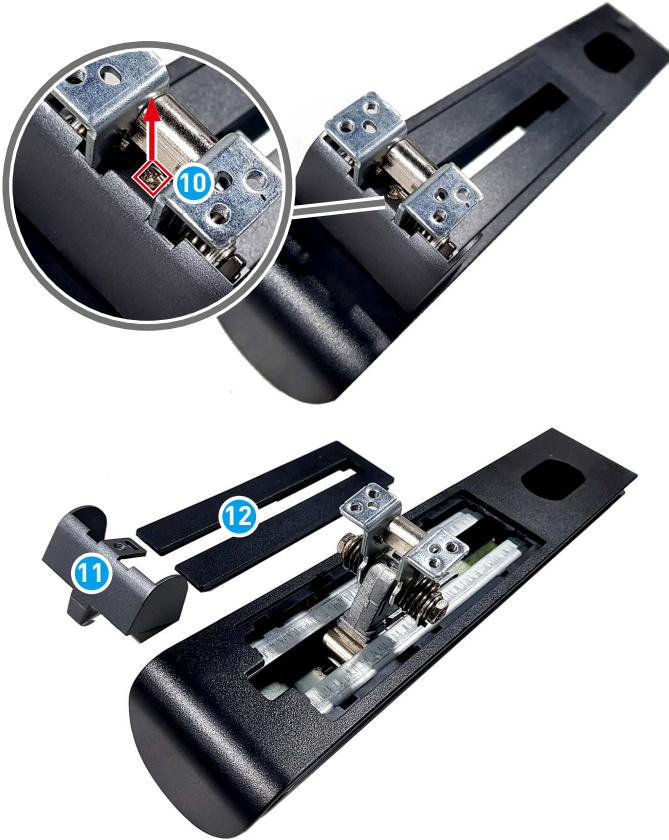

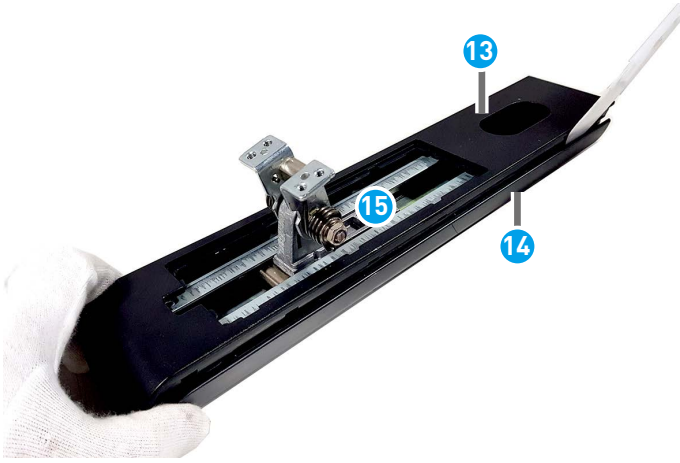

9. Please collect all recyclable plastic parts and send them to qualified recyclers for recycling.



Rear Cover & Panel Rear Cover

1. Follow [Rear Cover & Panel Rear Cover Disassembly](#) to disassemble the rear cover & panel rear cover from the computer.
2. Please recycle the panel rear cover ① & rear cover ② to qualified recyclers.

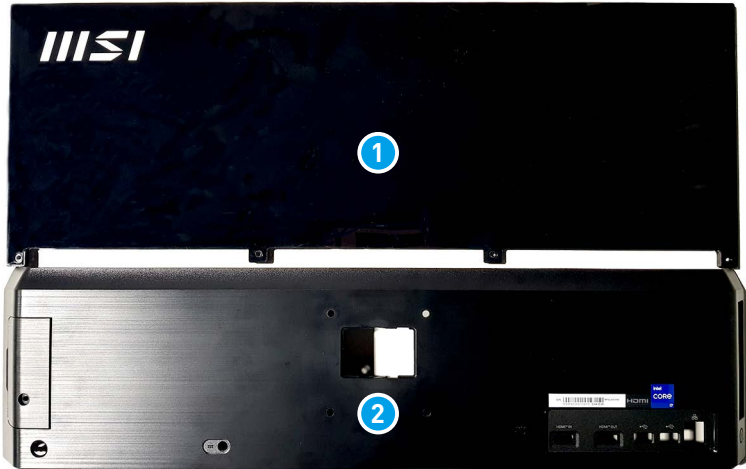

Deco Strip

1. Follow [Deco Strip Disassembly](#) to disassemble the deco strip from the computer.
2. Please recycle the deco strip **1** to qualified recyclers.



LCD Bezel

1. Follow [LCD Bezel & Panel Disassembly](#) to separate the LCD bezel and panel.
2. Release the middle bracket **1** by flipping over to the rear side and removing the screws **2** that secure the middle bracket with a cross-head screwdriver.
3. Locate and remove the screws **3** that secure the DC-in cable with a cross-head screwdriver and remove the DC-in cable **4** from the LCD bezel.
4. To remove the mainboard bracket **5**, pry around its edges with a parallel screwdriver until it is fully disengaged.
5. Use a cross-head screwdriver to remove all the screw bosses **6** with copper sticks.
6. Please recycle the LCD bezel **7** to qualified recyclers.

Front Side (Panel Side)

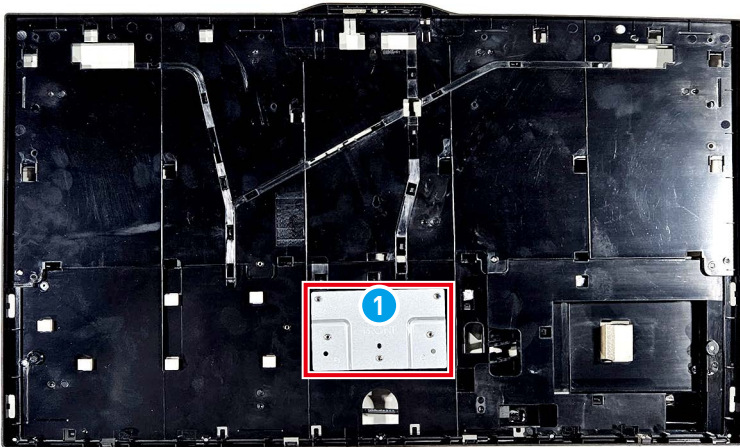

Rear Side

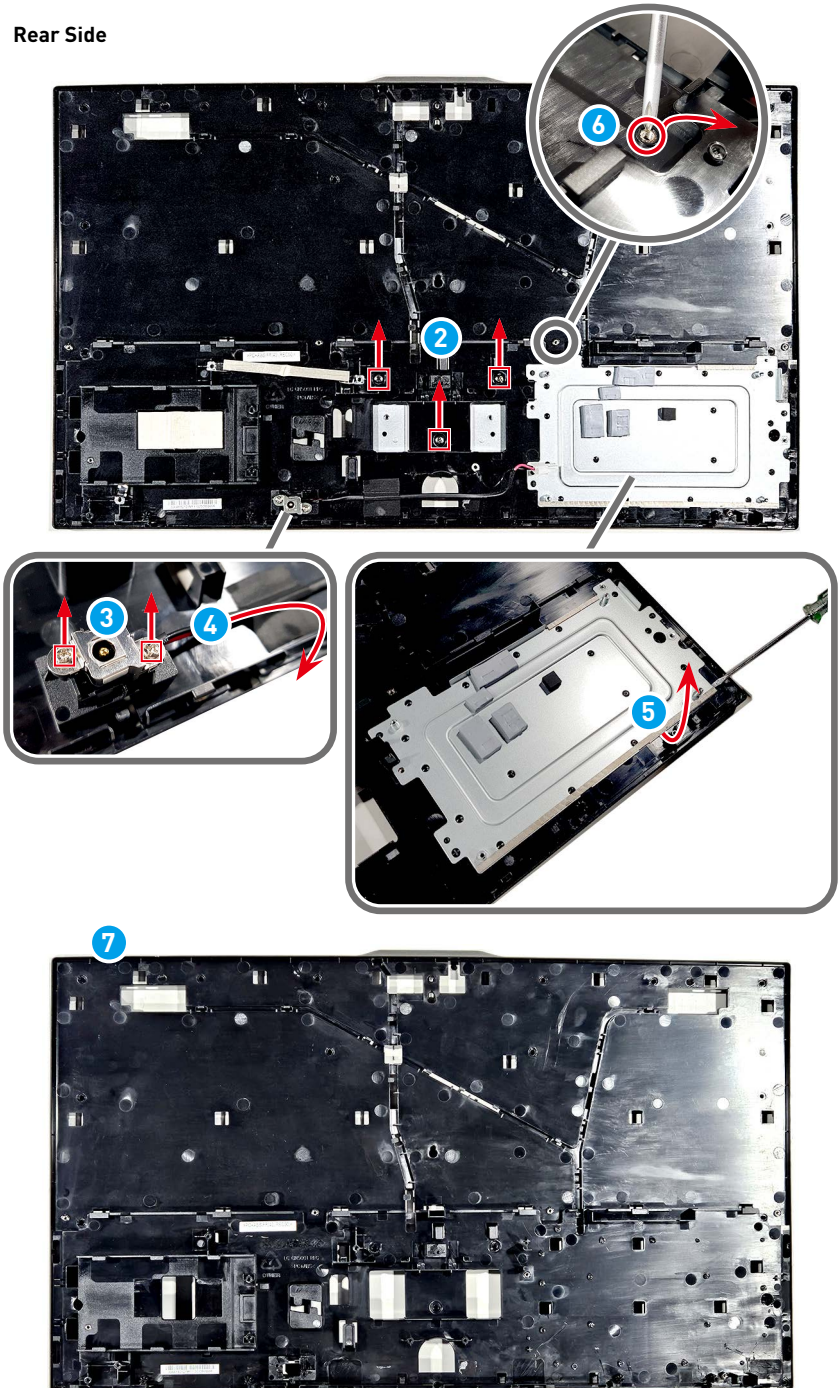

External Power Supply

1. Use diagonal pliers to cut the external power supply DC cable ①.
2. Use heat gun to heat the between ② of upper ③ and lower ④ cases of the power adapter, and then use a parallel screwdriver to separate the cases.
3. The disassembled upper ③ and lower ④ cases of the power adapter can be recycled by qualified recyclers.

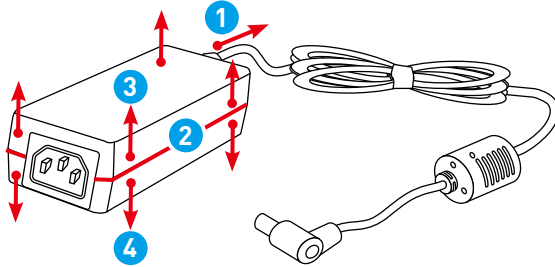

Product End-of-Life Instructions



Important

MSI Environmental Information

Information on MSI's Environmental initiatives, policies, programs and goals can be found at [Environmental Sustainability Policy](#).

Purpose

This information is to provide the guidance to recyclers on the presence of materials and components at the product level, as required by the EU WEEE and amending Directive.

Information on Component and Material Identification

The following substances, preparations, or components should be disposed of or recovered separately from other WEEE in compliance with Article 4 of EU Council Directive 75/442/EEC.

Identify materials for materials and components of the waste electrical and electronic equipment list.

*1: The following item numbers correspond with those in [Product Components and Accessories](#).

Materials	Item*1	Location
Polychlorinated biphenyl (PCB) containing capacitors and all polychlorinated biphenyls and polychlorinated terphenyls (PCB/PCT) containing electrical equipment	—	Absent
Mercury containing components, such as switches or backlighting lamps	—	Absent
Batteries	7	Battery
Printed circuit boards of mobile phones generally, and of other devices if the surface of the printed circuit board is greater than 10 square centimeters	8	Mainboard
	9	TPM Module
	10	Navi Board
	11	Converter Board
	17	External Power Supply Main PCB

Materials	Item*1	Location
Toner cartridges, liquid and paste, as well as color toner	—	Absent
Plastic containing abominated flame retardants	—	Absent
Asbestos waste and components which contain asbestos	—	Absent
Cathode ray tubes	—	Absent
Chlorofluorocarbons (CFC), Hydrochlorofluorocarbons (HCFC) or Hydrofluorocarbons (HFC), Hydrocarbons (HC)	—	Absent
Gas discharge lamps	—	Absent
Liquid crystal displays (together with their casing where appropriate) of a surface greater than 100 square centimeters and all those back-lighted with gas discharge lamps	15	LCD Panel
External electric cables	18	Power Cord
Components containing refractory ceramic fibers	—	Absent
Components containing radioactive substances, or materials that become radioactive	—	Absent
Electrolytic capacitors containing substances of concern (height > 25 mm, diameter > 25 mm or proportionately similar volume)	17	External Power Supply
Beryllium and its compounds (including Beryllium Oxide)	—	Absent
Liquids	—	Absent

Product Take-Back Service

Waste electrical equipment may contain hazardous substances and thus endanger human health & the environment. Proper disposal is therefore required. MSI provides free recycling of EPEAT-registered products to ensure that the product reaches the end of its useful life and that it is recycled responsibly.

To properly recycle your equipment through this service, please follow the steps:

1. Please delete your personal data from your waste equipment.
2. [CLICK HERE](#) to learn how to recycle your end-of-life product.
3. Find the MSI recycling location nearby on the website.
4. Contact the designated recycling location by phone or email to schedule your pickup. The customers are responsible for any shipping and delivery charges.

Using MSI Center

Login and Register

Before using MSI Center, it is recommended that you create your own account and register your MSI product to get full benefits from MSI Center at once.

Create an Account

1. Make sure the Internet connection works properly.
2. Activate MSI Center. Click the profile icon at the upper right corner and click [Login].

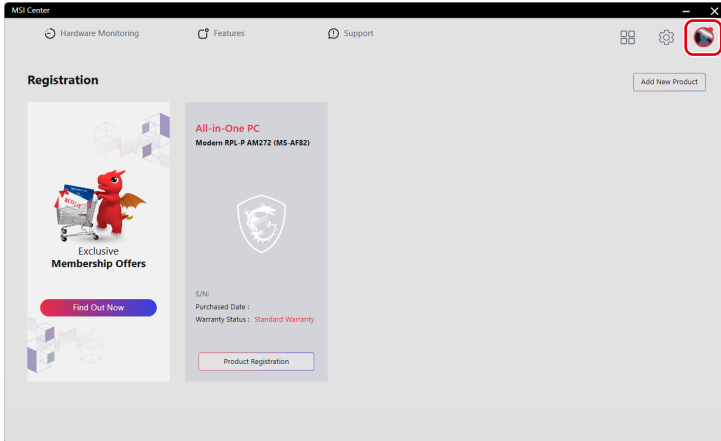

3. Select [Join MSI Member].

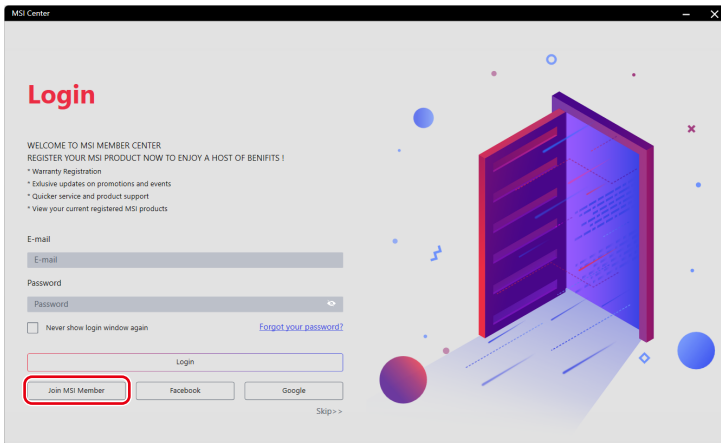

4. Follow the on-screen instructions to create a personal account.

The screenshot shows the 'CREATE AN ACCOUNT' form in the MSI Center application. The form includes the following fields and options:

- E-mail:** A text input field with the placeholder 'Please enter your email'.
- Password:** A text input field with the placeholder 'Please create a new password for MSI Center account'.
- Confirm Password:** A text input field with the placeholder 'Repeat the password entered above'.
- Name:** Two text input fields, one for 'Please enter your first name' and one for 'Please enter your last name'.
- Date of Birth:** Three dropdown menus for selecting day, month, and year.
- Region/Location:** A dropdown menu.
- Agreements:** Three checkboxes with associated text:
 - By clicking I agree to the MSI Reward Program Terms and condition. Become a member today to earn points, get exclusive offers, special VIP event invites and more! Join us. It's free and easy. Learn more about the benefits of the MSI Reward Program. [Terms and condition](#) and [MSI Reward Program](#).
 - I have read and agree to the MSI Terms of Use and Privacy Policy. [MSI Terms of Use](#) and [Privacy Policy](#).
 - Please send me the latest product information and event information of MSI.
- Navigation:** 'Prev' and 'Next' buttons.

Product Registration

Once a personal account is created, you may log in and start to register your products.

1. MSI Center will automatically detect your MSI devices. Click [Product Registration] and follow the on-screen instructions to complete the registration.
2. To register more MSI multimedia accessories connected to your system, click [Add New Product] and follow the on-screen instructions to add and register your accessories.

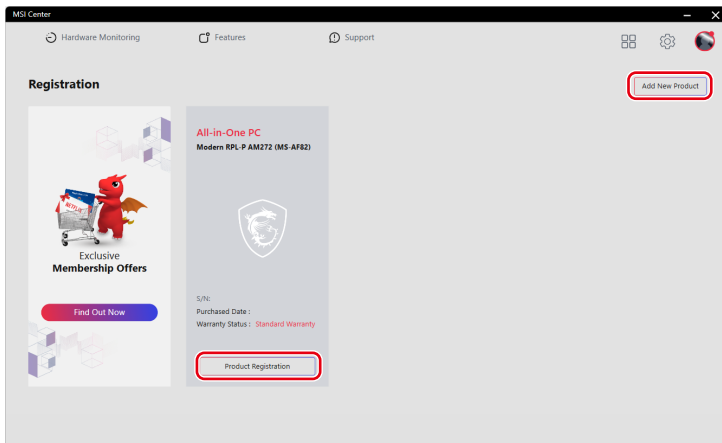

Feature Sets

Users can download, update or uninstall MSI exclusive features in Feature Sets.

1. Click the [Feature Sets] icon at the upper right corner.
2. Install or uninstall any MSI features to meet your personal needs.

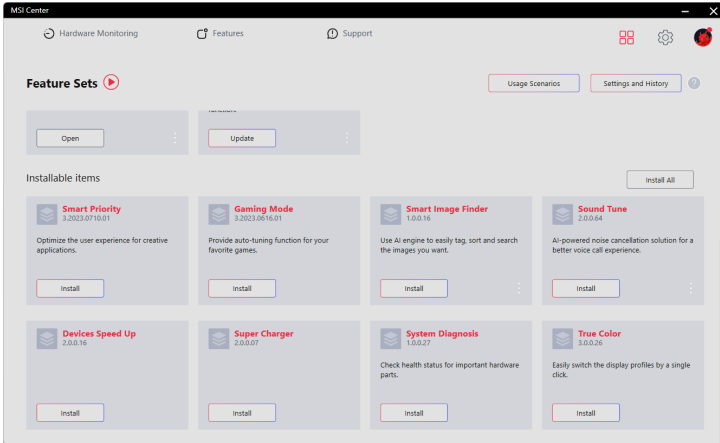
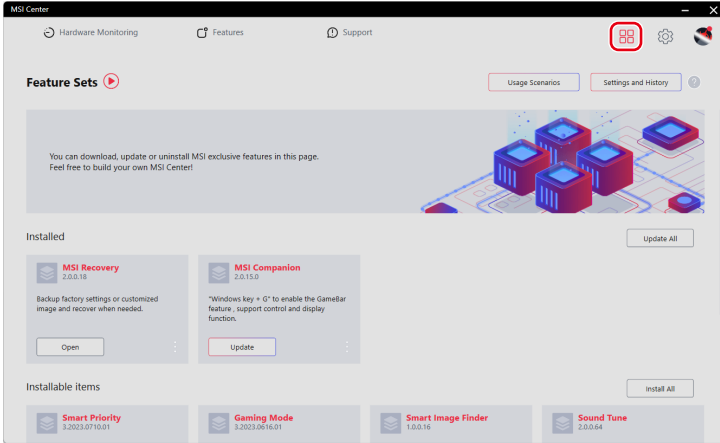

Hardware Monitoring

Hardware Monitoring provides real-time status of the CPU, GPU, memory, fans, etc. Click [Free Up Memory] to release system memory that is no longer required.

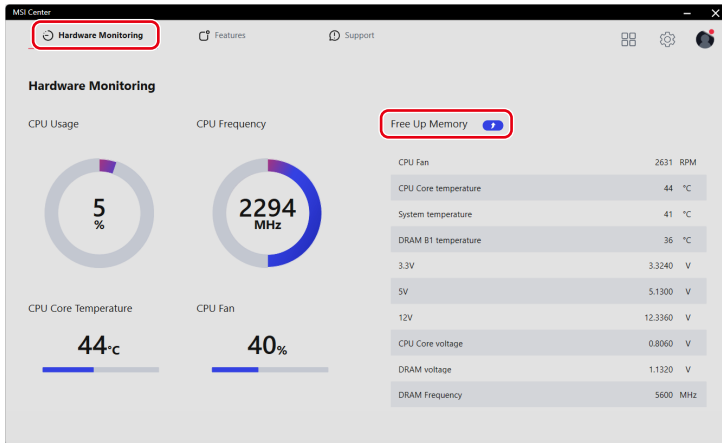

Features

[Features] will vary depending on the features users have installed through [Feature Sets].

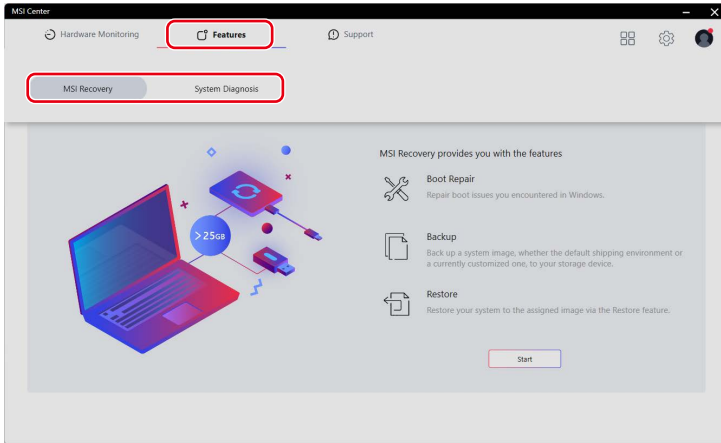

MSI Recovery

Use this function to make a recovery image to a USB flash disk to recover the system back to the initial status of original manufacturer's default settings, or the customized recovery point.



Important

Before using MSI Recovery, please back up the important data saved on your system drive to other storage devices.

Go to WinPE to Use MSI Recovery

1. Go to MSI Center [Features] > [MSI Recovery].
2. Click [Start] and then [Yes] to enter MSI Recovery main page under WinPE.

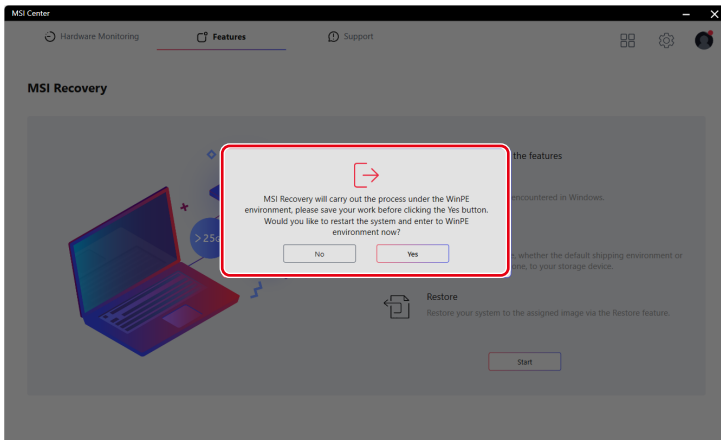
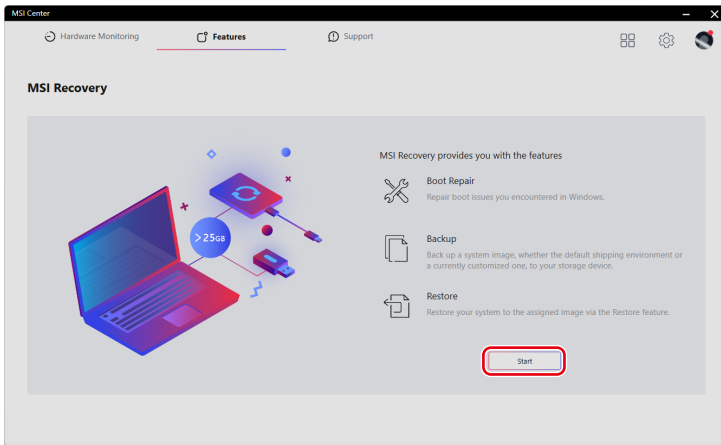

Backup: Creating an MSI Rescue USB disk

1. When using MSI Recovery for the very first time, it is a must to make an MSI Rescue USB disk first. With MSI Rescue USB disk, users may be able to fix or restore the system back to the factory default settings when the system encounters problems booting to Windows. Select [Backup] to start making the MSI Rescue USB disk.
2. Insert a USB disk with a minimum 32GB capacity. Click [Next] to continue.
3. Select the path of the inserted USB disk and click [Select] to continue.
4. Be noted that when making an MSI Rescue USB disk, the USB disk will be formatted and all data will be lost.
5. Follow the on-screen instructions to complete creating the MSI Rescue USB disk.
6. Keep the MSI Rescue USB disk properly, as it will be used whenever you perform the Backup and Restore functions.

Restore: Recovering the System

If the hard drive or the system encounters non-recoverable problems, it is recommended to proceed the MSI Recovery function with the MSI Rescue USB disk that you've made in advance.

1. Go to MSI Recovery main page, and select [Restore].
2. To perform the Restore function, always make sure that the MSI Rescue USB disk is inserted to the system.
3. You may restore the system from MSI Image Backup to have the system restored back to the factory default settings.
4. AC power is required while proceeding MSI Recovery. Ensure that the AC power is connected to the system before moving forward to the next step.
5. Always make sure that the important data has been backed up before continuing MSI Recovery process.
6. Follow the on-screen instructions to continue and complete the MSI Recovery process.

System Diagnosis

[System Diagnosis] provides [System Checker] for users to clean up their hard drives and free up system memory while [Storage Status] helps users keep their storage health in check.

- To clean up the storage, click [Clean Up Disk], select the drive you want to clean up from the pop-up menu, and follow the on-screen instructions to clean up the storage.
- To free up memory, click [Free Up Memory] and MSI Center will instantly release system memory that is no longer required.

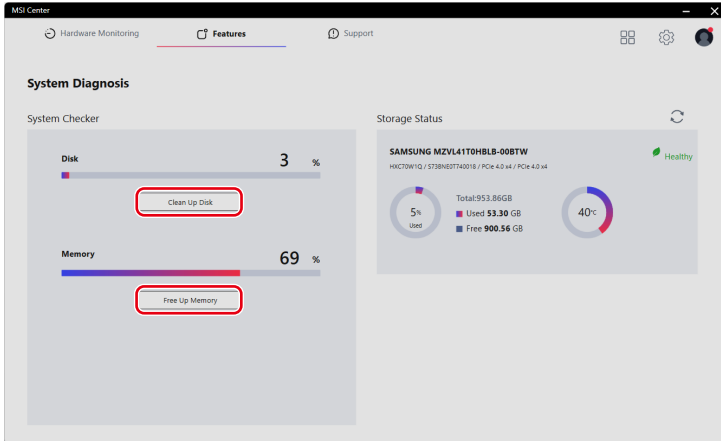

Support

Support offers various customer support channels to fulfill the needs of every user.

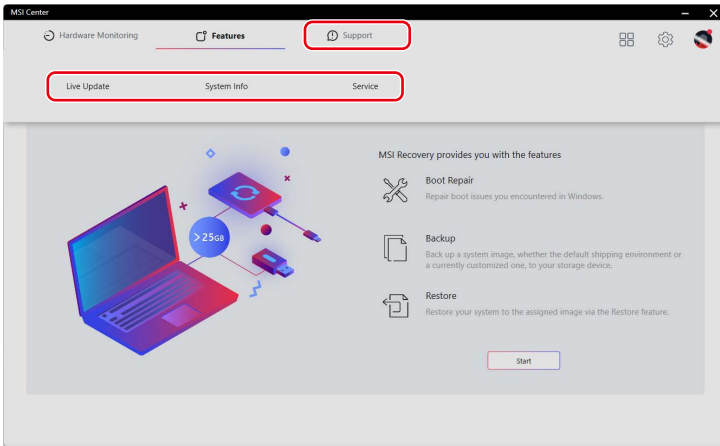

Live Update

Live Update

It is recommended that users click [Scan] under [Live Update] to get the latest MSI or third-party utilities for update.

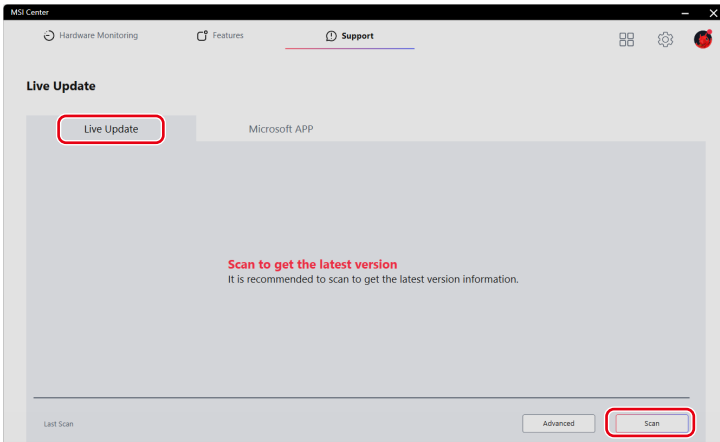

Microsoft APP

When using this function for the very first time, analyzing the system with Live Update is a must.

1. Click [Scan] under [Live Update].
2. Click [Microsoft APP] where a list of compatible applications on Microsoft Store are displayed.
3. Select a desired application and follow the on-screen instructions to install the application.

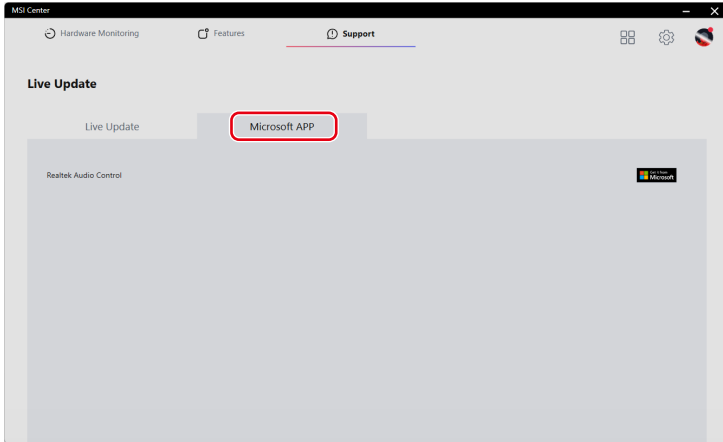

System Info

System Info shows read-only system information.

- [Export System Info]: Exporting the current system information data to a .txt file.
- [Scan]: Scanning the system for the latest information.

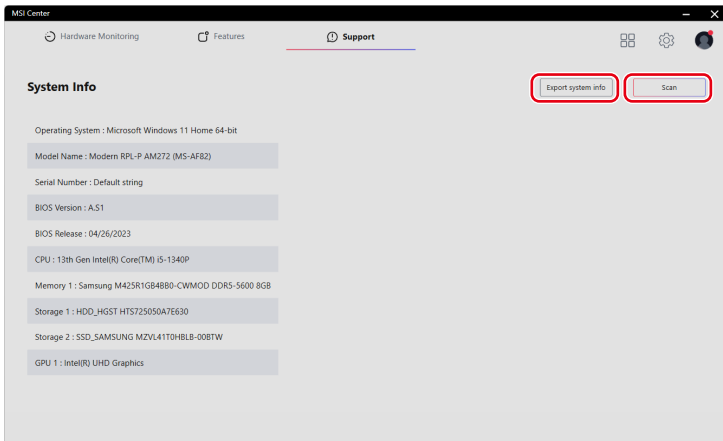

Service

Forum & Channel

- [MSI Forum]: Directing users to MSI Global Forum for discussion with global users.
- [How-To Channel]: Directing users to MSI HOW-TO CHANNEL for guides, tips & tricks that help you get more from your MSI products.

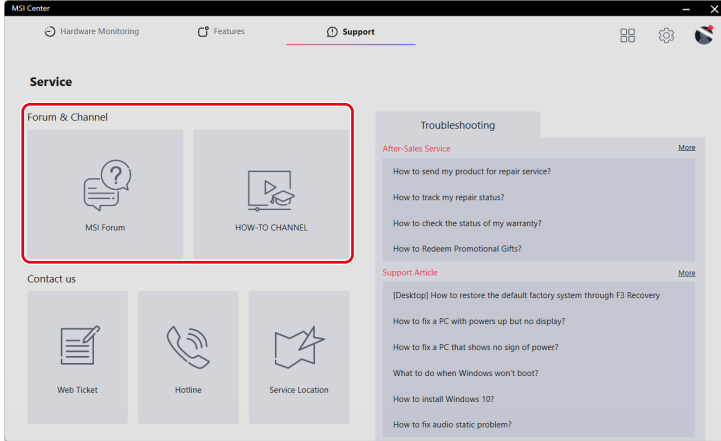

Contact Us

Users may contact MSI via the following channels.

- Click [Web Ticket] to reach MSI Member Center.
- Click [Hotline] to talk to a service representative.
- Click [Service Location] to locate a nearby repair service shop.

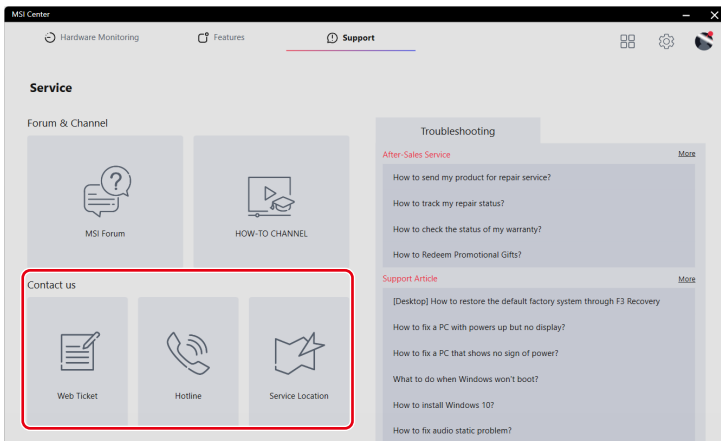

Troubleshooting

- [After-Sales Service]: Providing instructions on repair, warranty and other after-sales services.
- [Support Article]: Offering advice on how to troubleshoot your MSI products.

If further assistance is needed, click [More] for MSI online service and support.

