



# **PRO Series**

## **Personal Computer**

PRO DP80 A14G  
(MS-B208)

Service Guide

# Contents

|   |           |
|---|-----------|
| Copyright and Trademarks Notice.....          | 6         |
| Revision.....                                 | 6         |
| How to Use this Service Guide.....            | 6         |
| Safety Instructions.....                      | 7         |
| Power.....                                    | 7         |
| Battery.....                                  | 7         |
| Environment.....                              | 7         |
| Conditional Warranty Service.....             | 8         |
| Upgrade and Service.....                      | 8         |
| Data Sanitization.....                        | 8         |
| Publicly Available Service Information.....   | 9         |
| <b>Disassembly &amp; Assembly.....</b>        | <b>11</b> |
| Product Components and Accessories.....       | 12        |
| Product Upgradeability and Repairability..... | 13        |
| Recommended Tools.....                        | 14        |
| Screw List.....                               | 14        |
| Preparation for Disassembly.....              | 15        |
| Side Cover.....                               | 16        |
| Side Cover Disassembly.....                   | 16        |
| Side Cover Assembly.....                      | 16        |
| Front Bezel.....                              | 17        |
| Front Bezel Disassembly.....                  | 17        |
| Front Bezel Assembly.....                     | 17        |
| Antenna Module.....                           | 18        |
| Antenna Module Disassembly.....               | 18        |
| Antenna Module Assembly.....                  | 18        |
| Front Bracket.....                            | 19        |
| Front Bracket Disassembly.....                | 19        |
| Front Bracket Assembly.....                   | 19        |

|   |    |
|---|----|
| 3.5" HDD & 2.5" HDD (Optional) .....                | 20 |
| Hard Disk Drives Disassembly .....                  | 20 |
| Hard Disk Drives Assembly .....                     | 20 |
| ODD (Optional) .....                                | 21 |
| ODD Disassembly .....                               | 21 |
| ODD Assembly .....                                  | 21 |
| Front I/O Bracket, Front I/O Card .....             | 22 |
| Front I/O Bracket, Front I/O Card Disassembly ..... | 22 |
| Front I/O Bracket, Front I/O Card Assembly .....    | 22 |
| Intrusion Switch .....                              | 23 |
| Intrusion Switch Disassembly .....                  | 23 |
| Intrusion Switch Assembly .....                     | 23 |
| Graphics Card .....                                 | 24 |
| Graphics Card Disassembly .....                     | 24 |
| Graphics Card Assembly .....                        | 24 |
| Thermal Module .....                                | 25 |
| Thermal Module Disassembly .....                    | 25 |
| Thermal Module Assembly .....                       | 25 |
| CPU .....   | 26 |
| CPU Disassembly .....                               | 26 |
| CPU Assembly .....                                  | 26 |
| Memory Module .....                                 | 27 |
| Memory Module Disassembly .....                     | 27 |
| Memory Module Assembly .....                        | 27 |
| Solid-State Drive (Optional) .....                  | 28 |
| Solid-State Drive Disassembly .....                 | 28 |
| Solid-State Drive Assembly .....                    | 28 |
| Wireless Card .....                                 | 29 |
| Wireless Card Disassembly .....                     | 29 |
| Wireless Card Assembly .....                        | 29 |
| Coin Battery .....                                  | 30 |
| Coin Battery Disassembly .....                      | 30 |
| Coin Battery Assembly .....                         | 30 |

|  |    |
|--|----|
| COM Port .....   | 31 |
| COM Port Disassembly.....                                  | 31 |
| COM Port Assembly.....                                     | 31 |
| TPM Module.....  | 32 |
| TPM Module Disassembly.....                                | 32 |
| TPM Module Assembly.....                                   | 32 |
| Mainboard.....   | 33 |
| Mainboard Disassembly .....                                | 33 |
| Mainboard Assembly .....                                   | 33 |
| Power LED, HDD LED Cable .....                             | 34 |
| Power LED, HDD LED Cable Disassembly .....                 | 34 |
| Power LED, HDD LED Cable Assembly .....                    | 34 |
| Internal Power Supply (IPS).....                           | 35 |
| Internal Power Supply (IPS) Disassembly.....               | 35 |
| Internal Power Supply (IPS) Assembly .....                 | 35 |
| Wired Mouse (Optional) .....                               | 36 |
| Wired Mouse Disassembly.....                               | 36 |
| Wired Mouse Assembly.....                                  | 36 |
| Wired Keyboard (Optional) .....                            | 37 |
| Wired Keyboard Disassembly.....                            | 37 |
| Wired Keyboard Assembly.....                               | 38 |
| Powering Up After Maintenance.....                         | 39 |
| Troubleshooting.....                                       | 40 |
| Recycling Guidelines.....                                  | 42 |
| Front Bezel .....  | 42 |
| Thermal Module Fan .....                                   | 43 |
| Fan and Front Frame of the Graphics Card .....             | 44 |
| Internal Power Supply (IPS) .....                          | 46 |
| Wired Mouse (Optional).....                                | 48 |
| Wired Keyboard (Optional).....                             | 48 |
| Product End-of-Life Instructions .....                     | 49 |
| Purpose .....  | 49 |
| Information on Component and Material Identification ..... | 49 |

|                                 |           |
|---------------------------------|-----------|
| Product Take-Back Service ..... | 51        |
| <b>Using MSI Center .....</b>   | <b>53</b> |
| Login and Register .....        | 54        |
| Create an Account .....         | 54        |
| Product Registration .....      | 55        |
| Feature Sets .....              | 56        |
| Hardware Monitoring .....       | 57        |
| Features .....                  | 58        |
| System Diagnosis .....          | 59        |
| Support .....                   | 60        |
| Live Update .....               | 60        |
| System Info .....               | 61        |
| Service .....                   | 62        |

# Copyright and Trademarks Notice

Copyright © 2023 Micro-Star Int'l Co., Ltd. All rights reserved.

The MSI logo used is a registered trademark of Micro-Star Int'l Co., Ltd. Third-party trademarks and names are the properties of their respective owners. No warranty as to accuracy or completeness is expressed or implied. MSI reserves the right to make changes to this document without prior notice.

## Revision

V1.0, 2025/07

## How to Use this Service Guide

This Service Guide provides in-depth illustration of disassembling/assembling the product. Since the topics in this guide may be related, it is recommended that you read it from cover to cover first. After that, you may go directly to any specific topic that most meets your immediate needs.

# Safety Instructions

Adhere to safety precautions when handling the product to prevent harm or damage to individuals or the product's functionality.

## Power

- If the power cord comes with a 3-pin plug, do not disable the protective earth pin from the plug. The product must be connected to an earthed mains socket-outlet.
- Disconnect all power sources and place the product on a steady surface before disassembly/assembly.
- When unplugging the power cord, always hold the connector part of the cord. Never pull the cord directly.
- Place the power cord in a way that people are unlikely to step on it. Do not place anything on top of the power cord.
- If this product comes with an adapter, use only the MSI provided AC adapter approved for use with this product.

## Battery

Please take special precautions if this product comes with a battery.

- Danger of explosion if battery is incorrectly replaced. Replace only with the same or equivalent type recommended by the manufacturer.
- Avoid disposal of a battery into fire or a hot oven, or mechanically crushing or cutting of a battery, which can result in an explosion.
- Avoid leaving a battery in an extremely high temperature or extremely low air pressure environment that can result in an explosion or the leakage of flammable liquid or gas.
- Do not ingest battery. If the coin/button cell battery is swallowed, it can cause severe internal burns and can lead to death. Keep new and used batteries away from children.

## Environment

- Do not place the product in environments subject to mist, smoke, vibration, excessive dust, salty or greasy air, or other corrosive gases and fumes.
- To avoid electrostatic discharge, use an anti-static wrist strap before handling components. Always handle electrostatic-sensitive components, parts, and assemblies only at static-free work areas.
- Handle components with care. Do not touch the pins or contacts on a component.
- Place components on a grounded anti-static pad or on the bed that came with the components whenever the components are separated from the product.
- Do not perform any maintenance with wet hands.
- Prevent foreign substances, such as water, other liquids or chemicals, from entering the product while performing disassembly/assembly.
- After assembly, ensure that all screws are replaced and no stray screws remain inside the product.

# Conditional Warranty Service

MSI provides a conditional warranty service for selected models. Please visit [MSI Member Center](#) for further information.

# Upgrade and Service

Available hardware features may only be offered as part of an upgrade, repair, or replacement service offered by MSI or an authorized service provider.

MSI offers customers replacement parts, product repair and services for 3 years from the date of sale for all EPEAT-registered products.

Damages caused by servicing of products not authorized by MSI or the use of modified or non-MSI authorized parts or components are not covered by MSI Limited Warranty Agreement.

Visit [MSI Service Location](#) to obtain these services offered by MSI.

Go to [MSI Web Ticket](#) to receive further assistance if needed.

# Data Sanitization

MSI will not assume any responsibility or confidentiality obligation for the security of any data stored on the equipment submitted for recycling. Users are advised to back up and remove all data from the computers.

Before recycling, we recommend that users follow instructions on [Data Sanitization](#) to permanently and irreversibly remove all personal files, applications and settings from the computers.

# Publicly Available Service Information

| Service Information  | Section   |
|--|---|
| Disassembly instructions including identifying the required tools.   | <a href="#"><u>Product Components and Accessories</u></a><br><a href="#"><u>Recommended Tools</u></a> |
| Exploded diagram of parts.   | <a href="#"><u>Product Components and Accessories</u></a>   |
| List of spare parts including manufacturer-approved spare parts and how to obtain them.  | <a href="#"><u>Product Upgradeability and Repairability</u></a>                                       |
| Maintenance procedures or guidance on where to obtain the procedures.  | <a href="#"><u>System Diagnosis</u></a>   |
| Troubleshooting instructions, software diagnostic tools, troubleshooting videos or other troubleshooting guidance.   | <a href="#"><u>Troubleshooting</u></a><br><a href="#"><u>Service &gt; Troubleshooting</u></a>         |
| Instructions on how to obtain software updates (not applicable to display products).   | <a href="#"><u>Support</u></a>  |
| Instructions on how the user can remove personal data. If the instructions require destruction of the storage, instructions to replace the storage shall be provided (not applicable to display products). | <a href="#"><u>Data Sanitization</u></a>  |

**It is acceptable for service instructions to exclude information that, as determined by the manufacturer:**

|   |     |
|---|-----|
| a) May expose the user to risk of injury, or  | N/A |
| b) Breaches intellectual property rights, or  | N/A |
| c) Compromises user privacy or security, or   | N/A |
| d) Involves the disassembly of a battery pack or power supply   | N/A |
| If claiming any of the four exclusions above the manufacturer shall demonstrate how the product is restored to normal operating condition after being repaired. Repair may include replacement of the component(s) associated with the exclusion. | N/A |



# **Disassembly & Assembly**

# Product Components and Accessories

## Important

MSI provides the below list of components for the system configuration purchased and within 2 years after discontinuation of the product to increase the operational life of that product. Further services can be obtained by contacting [MSI Online Customer Service](#).

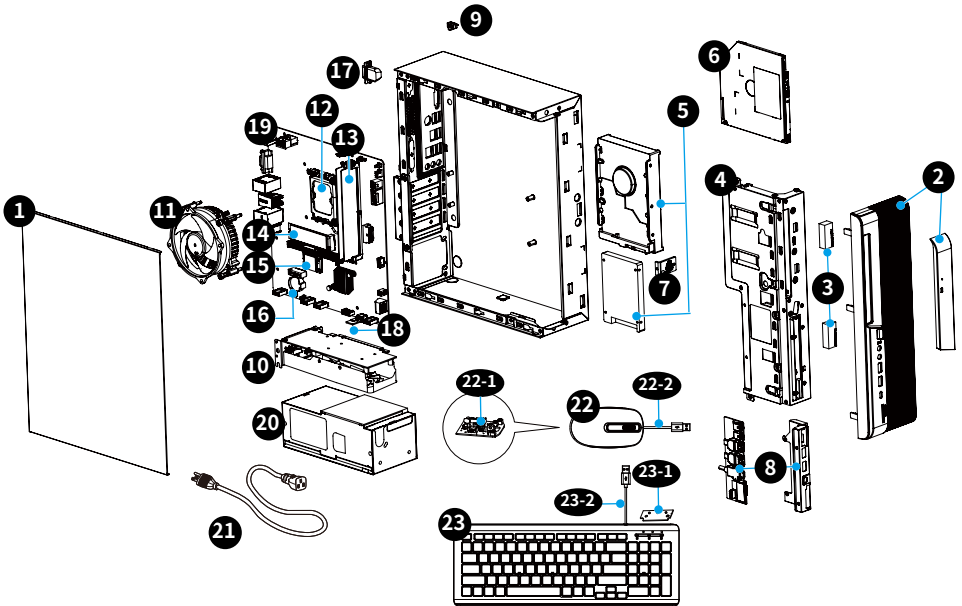

- |   |  |   |
|---|--|---|
| 1. <a href="#">Side Cover</a>                         | 10. <a href="#">Graphics Card</a>                | 20. <a href="#">Internal Power Supply (IPS)</a>           |
| 2. <a href="#">Front Bezel</a>                        | 11. <a href="#">Thermal Module</a>               | 21. Power Cord  |
| 3. <a href="#">Antenna Module</a>                     | 12. <a href="#">CPU</a>                          | 22. <a href="#">Wired Mouse (Optional)</a>                |
| 4. <a href="#">Front Bracket</a>                      | 13. <a href="#">Memory Module</a>                | 22-1. <a href="#">Wired Mouse PCB (Optional)</a>          |
| 5. <a href="#">3.5" HDD &amp; 2.5" HDD (Optional)</a> | 14. <a href="#">Solid-State Drive (Optional)</a> | 22-2. <a href="#">Wired Mouse USB Cable (Optional)</a>    |
| 6. <a href="#">ODD (Optional)</a>                     | 15. <a href="#">Wireless Card</a>                | 23. <a href="#">Wired Keyboard (Optional)</a>             |
| 7. <a href="#">Power Holder</a>                       | 16. <a href="#">Coin Battery</a>                 | 23-1. <a href="#">Wired Keyboard PCB (Optional)</a>       |
| 8. <a href="#">Front I/O Bracket, Front I/O Card</a>  | 17. <a href="#">COM Port</a>                     | 23-2. <a href="#">Wired Keyboard USB Cable (Optional)</a> |
| 9. <a href="#">Intrusion Switch</a>                   | 18. <a href="#">TPM Module</a>                   |   |
|   | 19. <a href="#">Mainboard</a>                    |   |

# Product Upgradeability and Repairability

Hardware features for upgradeable, repairable or replaceable using only commonly available tools and listing of replaceable spare parts by products can be obtained by contacting [MSI Online Customer Service](#).

Please refer to the following [hyperlinks](#) for specific details of the replacement or upgrade methods.

| Hardware feature items   | Upgradeable        | Repairable        | Replaceable        | Soldering        |
|--|--------------------|-------------------|--------------------|------------------|
| <a href="#">The main processor(s) or system on a chip (SOC)</a>                              | No                 | No                | Yes                | No               |
| <a href="#">Main memory capacity of the system</a>   | No                 | No                | No                 | No               |
| <a href="#">Mass storage capacity of the system</a>  | Yes                | No                | Yes                | No               |
| <a href="#">Wireless networking capability</a>   | No                 | No                | Yes                | No               |
| <a href="#">Graphics capability (integrated or discrete)</a>                                 | No                 | No                | Yes                | No               |
| Display panel or display assembly  | N/A                | N/A               | N/A                | N/A              |
| Integrated mechanical keyboards  | N/A                | N/A               | N/A                | N/A              |
| <a href="#">All batteries</a>  | No                 | No                | Yes                | No               |
| <a href="#">All external and internal power supplies</a>                                     | No                 | No                | Yes                | No               |
| <a href="#">All fan assemblies</a>   | No                 | No                | Yes                | No               |
| <b>AND At least two of the following (or one, if all remaining are absent from product):</b> | <b>Upgradeable</b> | <b>Repairable</b> | <b>Replaceable</b> | <b>Soldering</b> |
| Speakers   | N/A                | N/A               | N/A                | N/A              |
| Camera   | N/A                | N/A               | N/A                | N/A              |
| Touchpad   | N/A                | N/A               | N/A                | N/A              |
| I/O connectors and external power connection   | No                 | No                | No                 | Yes              |
| Readers (eg. magnetic stripe, Dallas key, fingerprint, Smart card)                           | N/A                | N/A               | N/A                | N/A              |

# Recommended Tools

The following tools may be needed while performing the disassembly and assembly procedures.

- Cross-head screwdriver
- Parallel screwdriver
- Hex socket screwdriver
- Tweezers
- Pry tool
- Needle-nose pliers
- Diagonal pliers
- Pointed flat-head screwdriver
- Anti-static gloves
- Anti-static wrist strap (optional)
- Anti-static mat with grounding wire (optional)

# Screw List

Please refer to the screw list below while proceeding the disassembly and assembly of the computer.

Note: This screw list is for reference only and may vary from models to models. It is highly recommended that users contact the authorized service center for further assistance.

| Component            | Screw Type                    | Quantity |
|----------------------|-------------------------------|----------|
| Side Cover           | Flat Head #6-32 × 5 mm        | 2        |
| Front Rotate Bracket | Flat Head #6-32 × L1 + 4.5mm  | 2        |
| ODD                  | Flat Head M2 × 3              | 2        |
| 3.5" HDD             | Flat Head #6-32 × 5 mm        | 4        |
| 2.5" HDD             | Flat Head M3 × 4              | 4        |
| Power Holder         | Countersunk Head B3×7         | 2        |
| Front I/O Bracket    | Countersunk Head #6-32 × 4    | 4        |
| Front I/O Card       | Flat Head M3 × 4              | 2        |
| COM Port Connector   | Hex #4-40 × 7 mm              | 2        |
| TFX IPS              | Flat Head M3×4                | 3        |
| Graphics Card        | Flat Head #6-32 × 5 mm        | 2        |
|                      | Countersunk Head #6-32 × 4 mm | 2        |
| Mainboard            | Flat Head M3 × 4              | 6        |
| Intrusion Switch     | Flat Head M2 × 8              | 2        |
| WiFi Card            | Countersunk Head M2 × 5       | 1        |

# Preparation for Disassembly

1. Power off the PC.
2. Disconnect the power cord from the electrical outlet.
3. Disconnect the power cord from the PC.

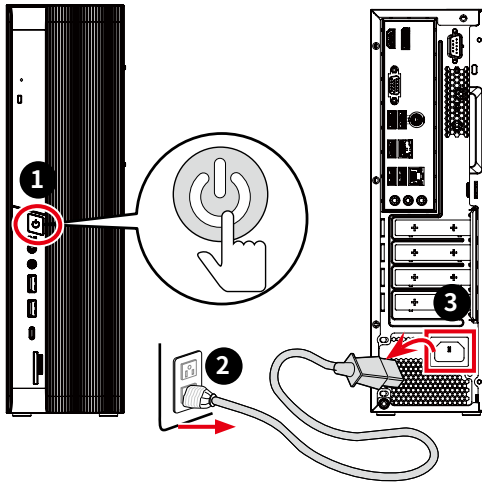

## Important

- *Disconnect all power sources and place the PC on a steady surface before disassembly/assembly.*
- *When unplugging the power cord, always hold the connector part of the cord. Never pull the cord directly.*
- *Do not place the PC in environments subject to mist, smoke, vibration, excessive dust, salty or greasy air, or other corrosive gases and fumes.*
- *To avoid electrostatic discharge, use anti-static gloves or an anti-static wrist strap before handling electrostatic-sensitive components.*
- *Do not perform any maintenance with wet hands.*
- *After assembly, ensure that all screws are replaced and no stray screws remain inside the PC.*

# Side Cover

## Side Cover Disassembly

---

1. Place the computer on a steady surface. Loosen and remove screws **1** with a cross-head screwdriver.
2. Insert your finger into the notch **2** and slide the side cover **3** outward to uncover the computer components.

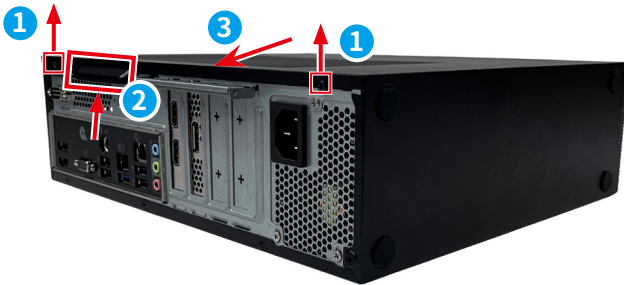

---

## Side Cover Assembly

To assemble the Side Cover, follow the disassembly steps in reverse.

---

# Front Bezel

## Front Bezel Disassembly

---

1. Use your fingers to release the clips **1**. Pry the front bezel **2** in the direction **3** illustrated to separate it from the front bracket.

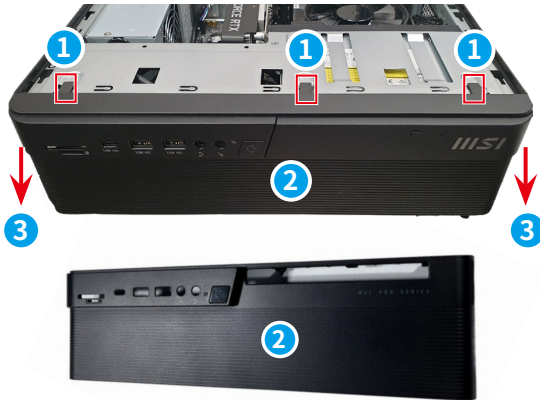

---

## Front Bezel Assembly

To assemble the Front Bezel , follow the disassembly steps in reverse.

---

# Antenna Module

## Antenna Module Disassembly

---

1. Use your fingers to peel off the adhesive tape **1** and remove the antenna module **2** from the front bracket.

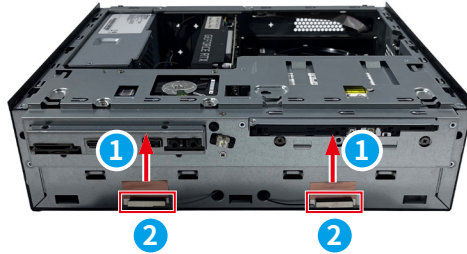

---

## Antenna Module Assembly

---

To assemble the Antenna Module, follow the disassembly steps in reverse.

---

# Front Bracket

## Front Bracket Disassembly

---

1. Using a cross-head screwdriver, loosen and remove screws **1** on both sides of the front bracket. Press detent clips **2** inward to rotate the front bracket **3**.
2. Disconnect the SATA **4**, Type-C **5** and USB **6** connectors by hand to finish.

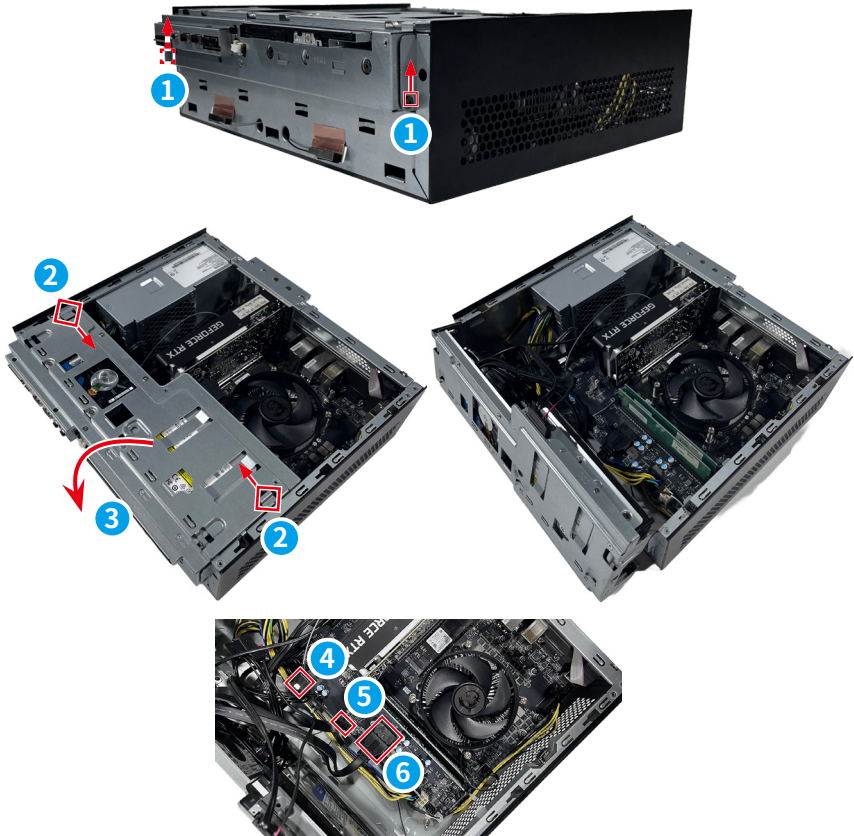

---

## Front Bracket Assembly

---

To assemble the Front Bezel, follow the disassembly steps in reverse.

---

# 3.5" HDD & 2.5" HDD (Optional)

## Hard Disk Drives Disassembly

---

1. **2.5" HDD (optional):** Remove HDD power **1**, and data **2** cables by hand. Flip over the front I/O bracket, loosen and remove screws **3** to take out the 2.5" HDD using a cross-head screwdriver.
2. **3.5" HDD (optional):** Remove HDD power **4**, and data **5** cables by hand. Loosen and remove screws **6** and **7** at both sides to take out the 3.5" HDD using a cross-head screwdriver.

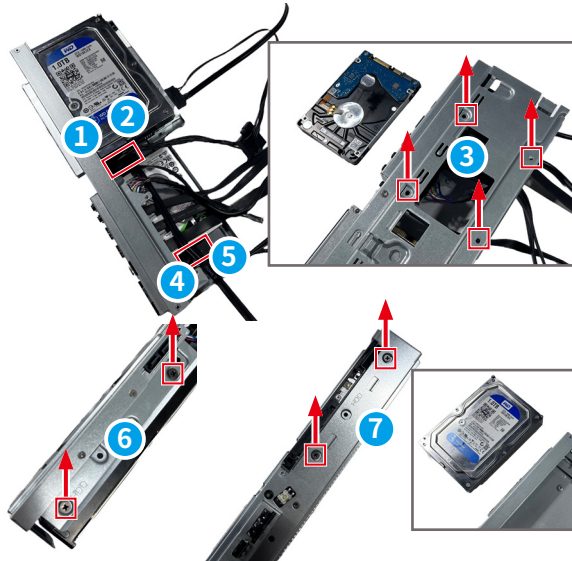

---

## Hard Disk Drives Assembly

To assemble the Front Bezel, follow the disassembly steps in reverse.

---

# ODD (Optional)

## ODD Disassembly

---

1. Insert a paperclip into the eject hole **1**, gently push until the ODD tray pops out slightly. Pull it outward **2**, then use a tool to push the bottom latch **3** and remove the ODD cover **4** from the ODD tray by hand.
2. Remove ODD power cable **5** by hand. Loosen and remove the screws **6** on the front bracket **7** using a cross-head screwdriver, then take out the ODD **8**.



---

## ODD Assembly

To assemble the Optical Disc Drive, follow the disassembly steps in reverse.

---

# Front I/O Bracket, Front I/O Card

## Front I/O Bracket, Front I/O Card Disassembly

---

1. Using a cross-head screwdriver to loosen and remove the screws **1** on the front bracket **2**. Take out the front I/O bracket **3** by hand.
2. Using a cross-head screwdriver to loosen and remove the screws **4** on the front I/O card **5** using a cross-head screwdriver. Separate the front I/O bracket and front I/O card. Loosen and remove screws **6** that secure the USB-C connector with a cross-head screwdriver. Then cut the remaining cables **7** with diagonal pliers.

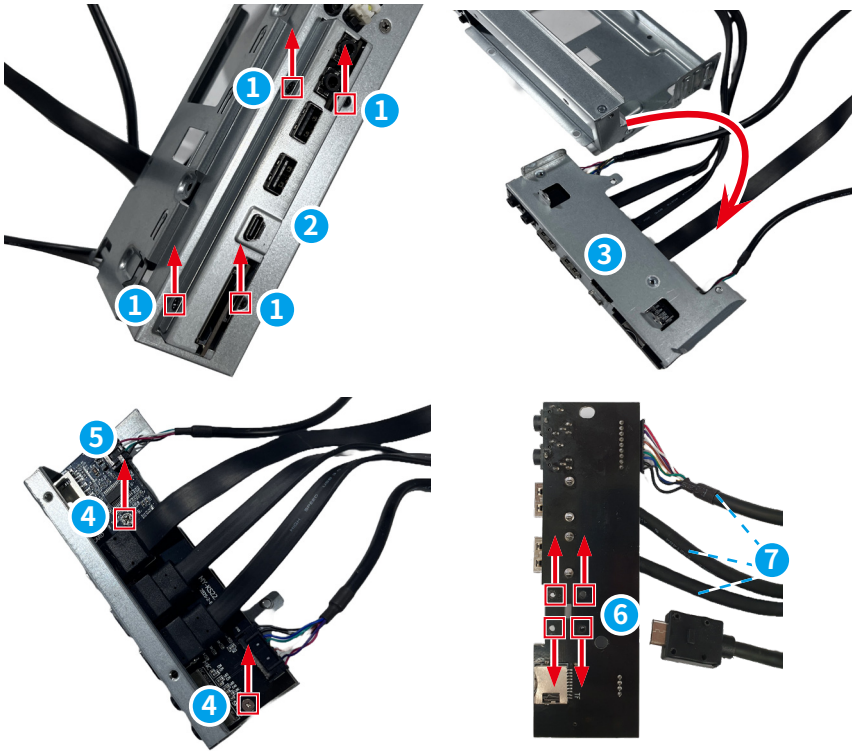

---

## Front I/O Bracket, Front I/O Card Assembly

To assemble the Front I/O Bracket and Front I/O Card, follow the disassembly steps in reverse.

---

# Intrusion Switch

## Intrusion Switch Disassembly

---

1. Loosen and remove the screws **1** that secure the intrusion switch **2** with a cross-head screwdriver.

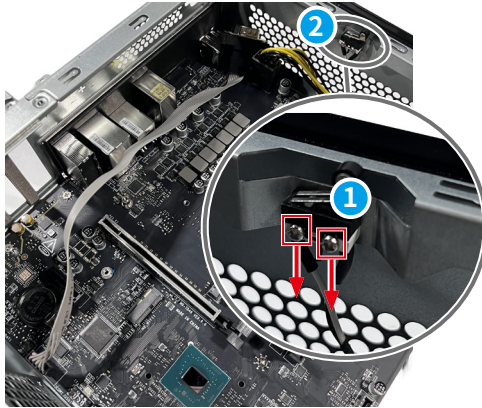

---

## Intrusion Switch Assembly

---

To assemble the Intrusion Switch, follow the disassembly steps in reverse.

---

# Graphics Card

## Graphics Card Disassembly

---

1. Using a cross-head screwdriver, loosen and remove the screws **1** on the rear I/O bracket and chassis that secure the graphics card **2**.
2. Lift the VGA flip cover **3** and press the retention clip **4** to remove the graphics card **2** by hand, revealing the PCIe slot **5**.

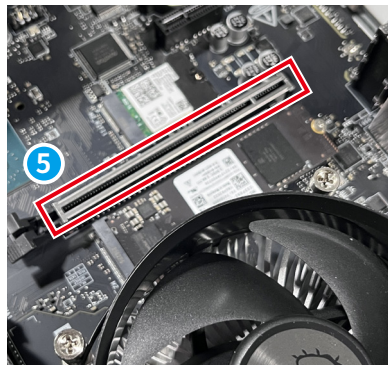
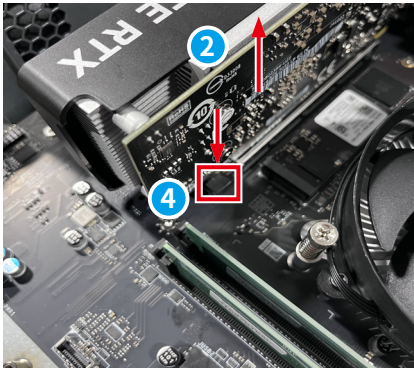
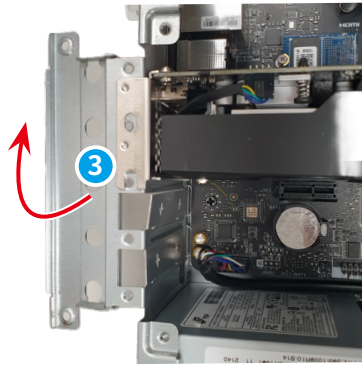
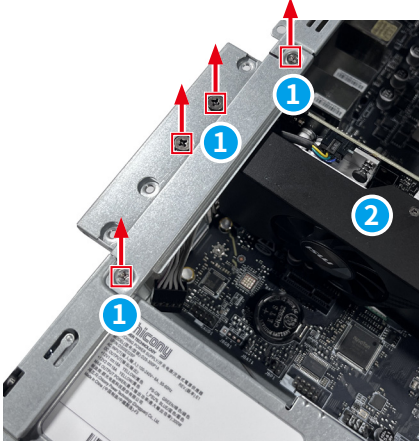

## Graphics Card Assembly

---

To assemble the Graphics Card, follow the disassembly steps in reverse.

---

# Thermal Module

## Thermal Module Disassembly

---

1. Disconnect the CPU fan cable **1** from the mainboard by hand.
2. Loosen and remove the screws **2** that secure the thermal module **3** with a cross-head screwdriver. Lift the thermal module and its cable off the mainboard by hand.

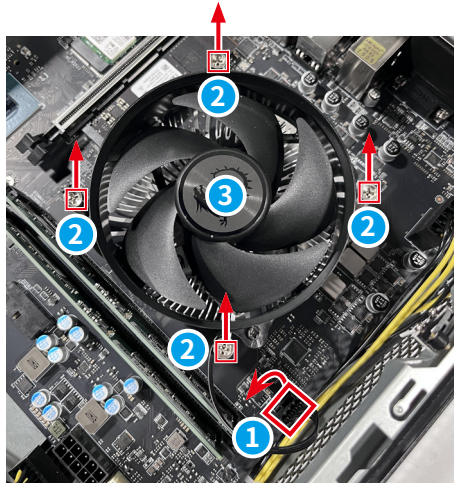

---

## Thermal Module Assembly

To assemble the Thermal Module, follow the disassembly steps in reverse.

---

# CPU

## CPU Disassembly

---

1. Push the load lever down to unclip the CPU socket. Lift the load lever up to the fully open position ① by hand and the load plate will automatically lift up ②.
2. Remove the CPU ③ straight up from the socket without tilting the CPU.
3. Close the load plate ② and then close the load lever ①.

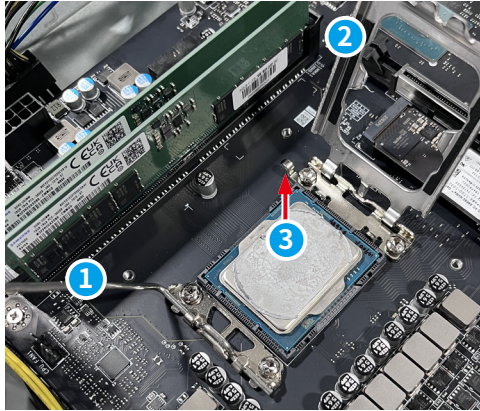

---

## CPU Assembly

---

To assemble the CPU, follow the disassembly steps in reverse.

---

# Memory Module

## Memory Module Disassembly

---

1. Locate and open the slot clips **1** on the memory module slot until the memory module **2** pops up, then remove the memory module.
2. Repeat these steps for any additional memory modules.

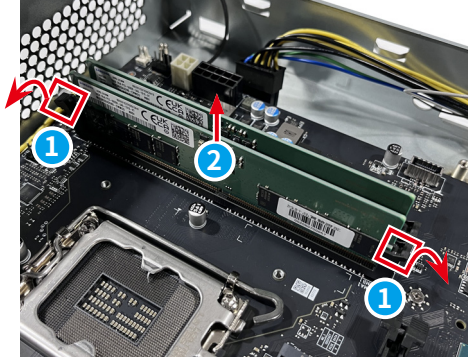

---

## Memory Module Assembly

To assemble the Memory Module, follow the disassembly steps in reverse.

---

# Solid-State Drive (Optional)

## Solid-State Drive Disassembly

---

1. Remove the screws **1** that secure the solid-state drive with a cross-head screwdriver.
2. Slide and remove the solid-state drive **2** from the M.2 slot by hand.

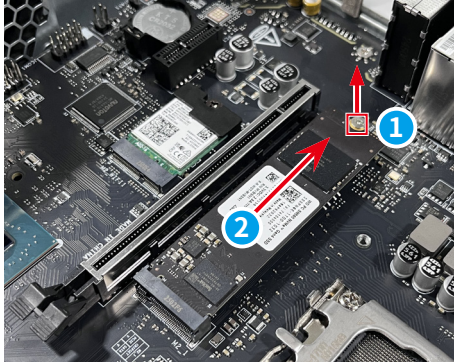

---

## Solid-State Drive Assembly

To assemble the Solid-State Drive, follow the disassembly steps in reverse.

---

# Wireless Card

## Wireless Card Disassembly

---

1. Locate and remove the wireless card clip **1** and remove the screw **2** that secures the wireless card with a cross-head screwdriver.
2. Disconnect the antenna cables **3** and remove the wireless card **4** from the card slot by hand.

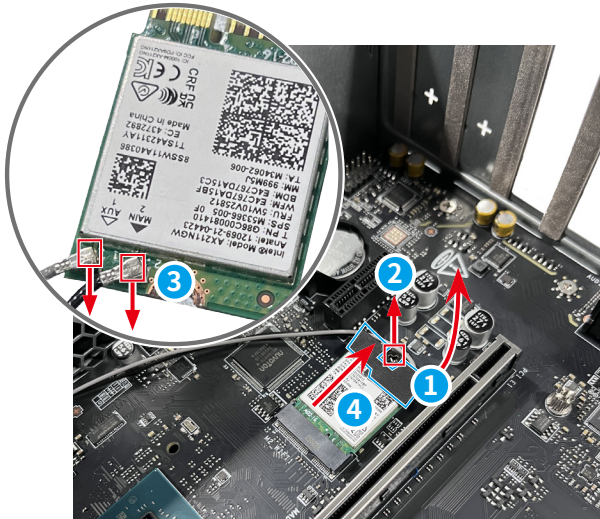

---

## Wireless Card Assembly

To assemble the Wireless Card, follow the disassembly steps in reverse.

---

# Coin Battery

## Important

- *Danger of explosion if battery is incorrectly replaced. Replace only with the same or equivalent type recommended by the manufacturer.*
- *Avoid disposal of a battery into fire or a hot oven, or mechanically crushing or cutting of a battery, which can result in an explosion.*
- *Avoid leaving a battery in an extremely high temperature or extremely low air pressure environment that can result in an explosion or the leakage of flammable liquid or gas.*
- *Do not ingest battery. If the coin/button cell battery is swallowed, it can cause severe internal burns and can lead to death. Keep new and used batteries away from children.*

## Coin Battery Disassembly

---

1. Use tweezers to remove the plastic clip **1**. Push the retaining clip **2** to release the battery, then remove it **3** with your fingers.

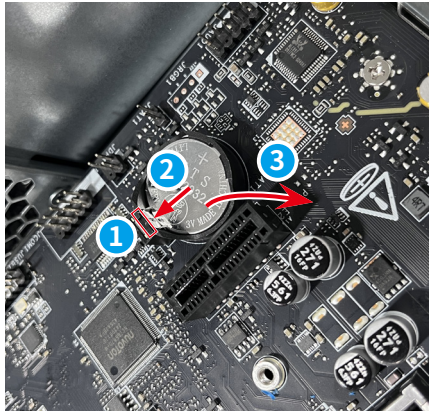

## Coin Battery Assembly

---

To assemble the Coin Battery, follow the disassembly steps in reverse.

---

# COM Port

## COM Port Disassembly

---

1. Locate and remove the screws **1** that secure the COM port connector with a hex socket screwdriver. Remove the COM port connector **2** and the other end of cable **3** from the mainboard.

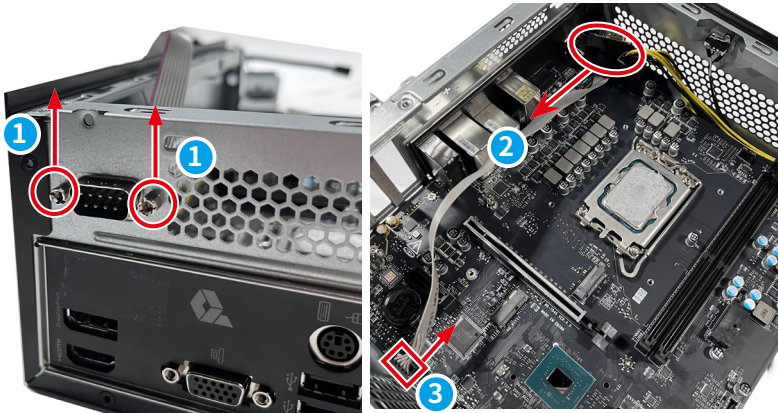

---

## COM Port Assembly

To assemble the COM Port Connector, follow the disassembly steps in reverse.

---

# TPM Module

## TPM Module Disassembly

---

1. Use your fingers to grab the edge of the TPM module **1** and gently pull it off the mainboard.

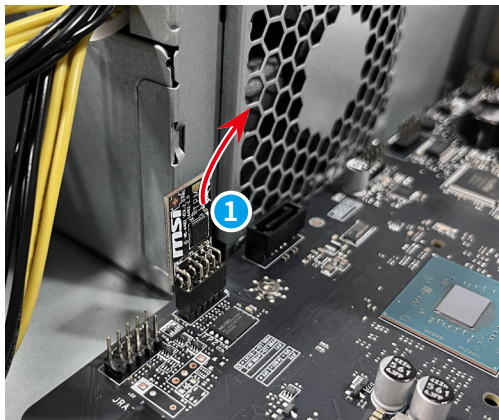

---

## TPM Module Assembly

---

To assemble the TPM Module, follow the disassembly steps in reverse.

---

# Mainboard

## Mainboard Disassembly

---

1. Locate and remove the ATX **1** and CPU power connector **2** using your fingers.
2. Locate and remove the mainboard standoff screws **3** with a cross-head screwdriver. Take out the mainboard **4** by hand.

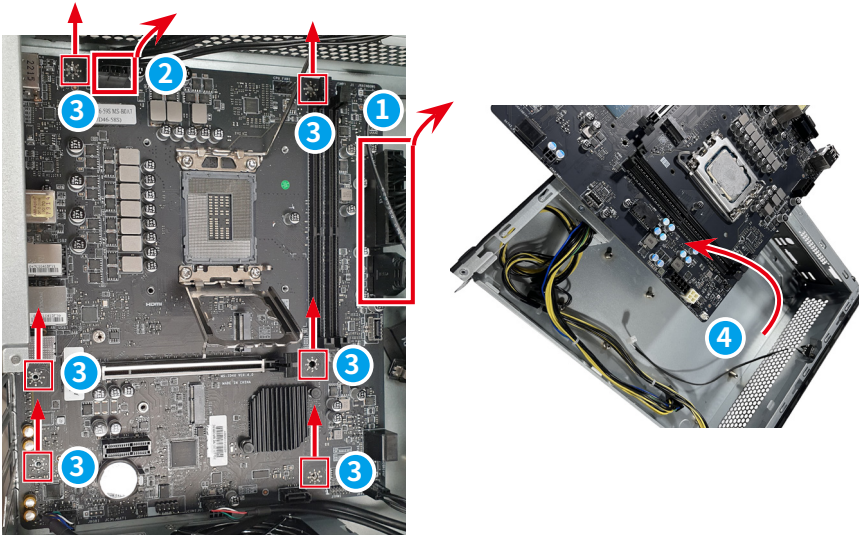

## Mainboard Assembly

---

To assemble the Mainboard, follow the disassembly steps in reverse.

---

# Power LED, HDD LED Cable

## Power LED, HDD LED Cable Disassembly

---

1. Loosen and remove the screws **1** on the front bracket **2** using a cross-head screwdriver. Then remove the power holder **3** and disconnect the front panel cable **4** by hand.

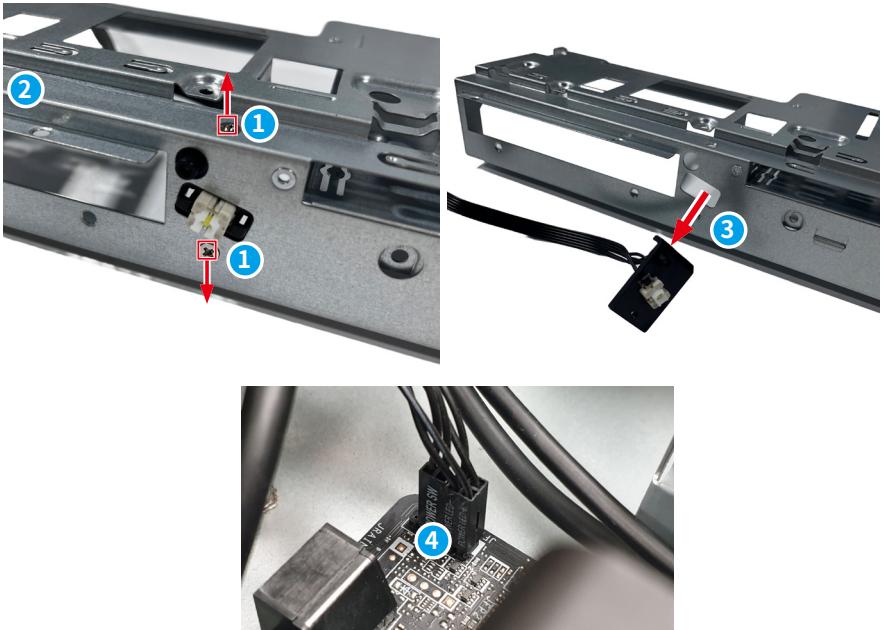

## Power LED, HDD LED Cable Assembly

---

To assemble the Intrusion Switch, follow the disassembly steps in reverse.

---

# Internal Power Supply (IPS)

## Internal Power Supply (IPS) Disassembly

---

1. Loosen and remove the screws **1** with a cross-head screwdriver. Remove the IPS from the cover **2**.



---

## Internal Power Supply (IPS) Assembly

To assemble the TPM Module, follow the disassembly steps in reverse.

---

# Wired Mouse (Optional)

## Wired Mouse Disassembly

---

1. Remove the feet stickers **1** using a parallel screwdriver. Use a cross-head screwdriver to remove the screw **2**.
2. Separate the top case **3** and key plate **4** using your fingers.
3. Use a cross-head screwdriver to remove the screws **5** that secured the PCB **6**.
4. Remove the the wired mouse USB cable **7**, wheel **8** and bottom case **9** with your fingers.

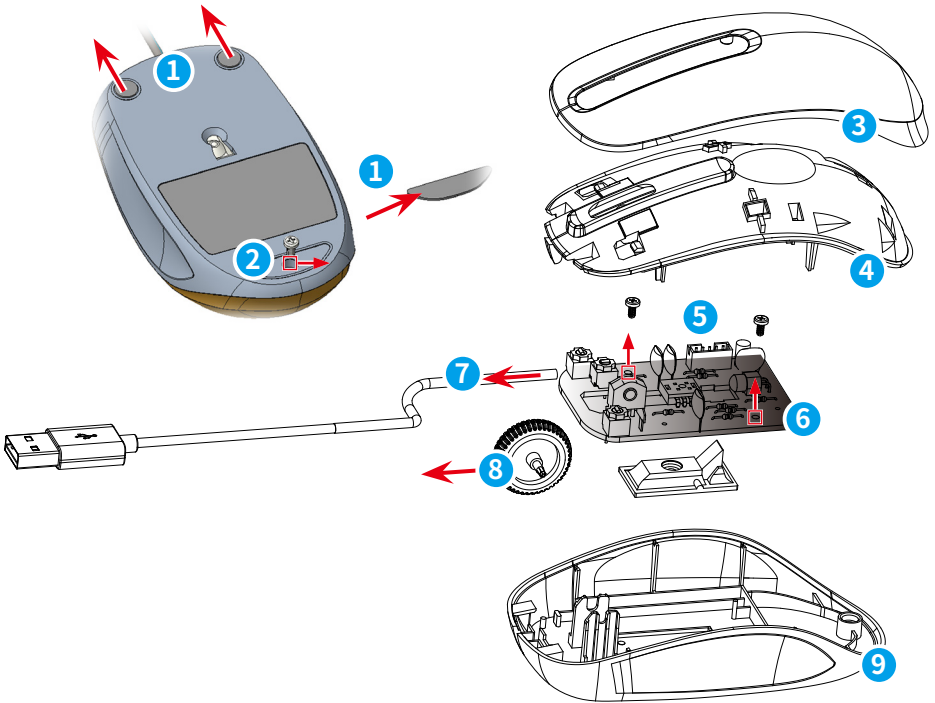

---

## Wired Mouse Assembly

---

To assemble the wired mouse, follow the disassembly steps in reverse.

---

# Wired Keyboard (Optional)

## Wired Keyboard Disassembly

---

1. Loosen and remove the screws **1** with a cross-head screwdriver.
  2. Flip the keyboard over, use a pry tool to separate the top case **2**.
  3. Use a cross-head screwdriver to loosen and remove screws **3**, then detach the PCB **4** and wired keyboard USB cable **5** from the PCB with your fingers.
  4. Remove the rubber sheet **6** and the membrane **7** with your fingers to unveil the bottom case **8**.
-

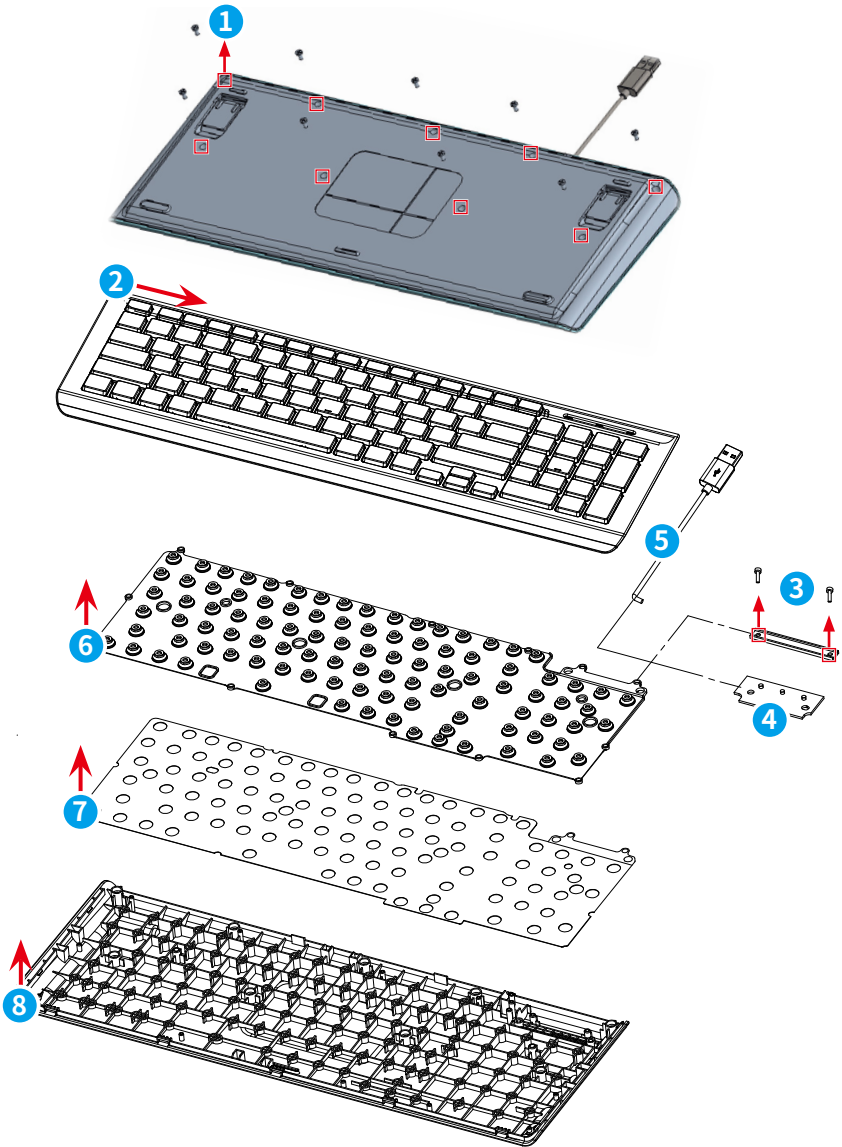

---

## Wired Keyboard Assembly

To assemble the wired keyboard, follow the disassembly steps in reverse.

---

# Powering Up After Maintenance

1. Connect the power cord to the PC.
2. Plug the power cord into the electrical outlet.
3. Power on the PC.

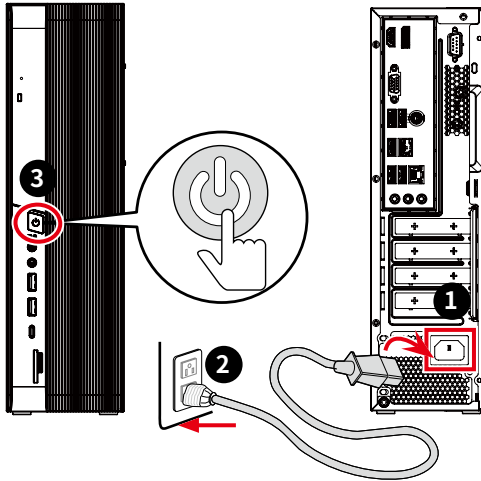

## Important

- Use only the MSI provided AC adapter approved for use with this PC.
- If the power cord comes with a 3-pin plug, do not disable the protective earth pin from the plug. The PC must be connected to an earthed mains socket-outlet.
- Plug the power cord into an electrical outlet that is easily accessible at all times.
- Place the power cord in a way that people are unlikely to step on it. Do not place anything on the power cord.
- Always disconnect the power cord or switch the wall socket off if the PC would be left unused for a certain time to achieve zero energy consumption.

# Troubleshooting

Users may refer to the following tips or visit [MSI Support](#) and [Troubleshooting](#) for quick and easy troubleshooting when encountering common problems with the product. It is always suggested that users contact the authorized MSI service center for advanced tech support if needed.

## My system does not start.

- Check if the system is connected to an electrical outlet and it is turned on.
- Check if the power cord and all cables are connected firmly.

## The system can not be shut down.

It is best to shut down your computer using the Shut Down icon in the operating system. Using other methods, including those listed below, may result in data failure. If the Shut Down procedure does not work, choose one of the following steps:

- Press Ctrl+Alt+Del keys, then choose Shut Down.
- Press and hold the power button till the system is off.
- Unplug the power cable from the system.

## The Internet connection has problems.

- If you are having a problem connecting to your Internet Service Provider (ISP), check if the ISP is experiencing technical problems.
- Check the Network settings and connection and make sure the system is properly configured to Internet access.
- The wireless LAN data transfer speed is affected by distance and obstructions between devices and access points. To maximize the data transfer speed, choose the access point closest to your system.

## How to recover the system with the F3 Hotkey?

### Precautions for Using the System Recovery Function

- If your hard drive and system encountered non-recoverable problems, please use the F3 Hotkey recovery from the Hard Drive first to perform the System Recover Function.
- Before using the System Recovery Function, please back up the important data saved on your system drive to other storage devices.

### Recovering the system with the F3 Hotkey

1. Restart the PC.
2. Press the F3 hotkey on the keyboard promptly when the MSI greeting appears on the display.
3. On the [Choose an option] screen, select [Troubleshoot].
4. On the [Troubleshoot] screen, select [Restore MSI factory settings] to reset the system to the default settings.
5. On the [RECOVERY SYSTEM] screen, select [System Partition Recovery].

6. Follow the on-screen instructions to continue and complete the Recovery Function.

**System speakers do not work.**

- Check the master volume setting in the Audio Mixer.
- If you are using an application that has its own volume control, check if the volume is muted.
- If you have connected an audio cable to the Headphone jack, disconnect it.
- If the system has OSD function, please adjust the volume of OSD.

**My wired mouse or keyboard doesn't work.**

- First, check your hardware. If it still doesn't work, remove the USB hub and plug the device directly into the PC's USB port. Ensure the cables aren't damaged.

# Recycling Guidelines

In line with our commitment to environmental sustainability, this product is designed with separable plastic components to enhance plastic recycling quality. We kindly request that you responsibly recycle the recyclable plastic components of this product once it reaches the end of its useful life. Follow the instructions below to prepare plastic parts for recycling by eliminating non-recyclable materials.

## **Important**

*Before recycling the separable plastic components, please use diagonal pliers to remove all the screw bosses with copper sticks, if any.*

## Front Bezel

---

1. Follow [Front Bezel Disassembly](#) to remove the front bezel.
2. Please recycle the front bezel  to qualified recyclers.



## Thermal Module Fan

1. Follow [Thermal Module Disassembly](#) to remove the thermal module and its cable off the mainboard. Use a cross-head screwdriver to loosen and remove screws **1**, then detach heatsink **2** and the fan **3**.
2. Hold the fan frame **4** with both hands and push out the fan blades **5** with your thumbs. Remove motor **6** with needle-nose pliers, then twist out bearing **7** using a pointed flat-head screwdriver. Cut the PCB-to-motor pins **8** with diagonal pliers, then remove the PCB **9**.
3. Please recycle the fan frame **4**, fan blades **5** and PCB **9** to qualified recyclers.



## Fan and Front Frame of the Graphics Card

---

1. Follow [Graphics Card Disassembly](#) to remove the graphics card from the mainboard.
  2. Use a cross-head screwdriver to loosen and remove the screws ① securing the front frame ② to the graphics card heatsink ③, and screws ④ securing the heatsink ③ and mainboard ⑤.
  3. Disconnect the fan connector ⑥ by hand, loosen and remove the screws ⑦ securing the fan ⑧ and the front frame ② using a cross-head screwdriver.
  4. Use diagonal pliers to cut the fan cable ⑨, remove the fan by hand.
  5. Separate the fan blade ⑩ and fan frame bracket ⑪ using a parallel screwdriver. Remove motor ⑫ with needle-nose pliers, then twist out bearing ⑬ using a pointed flat-head screwdriver. Cut the PCB-to-motor pins ⑭ with diagonal pliers, then remove the PCB ⑮.
  6. Please recycle front frame ②, the fan blades ⑩, and PCB ⑮ of the graphics card to qualified recyclers.
-

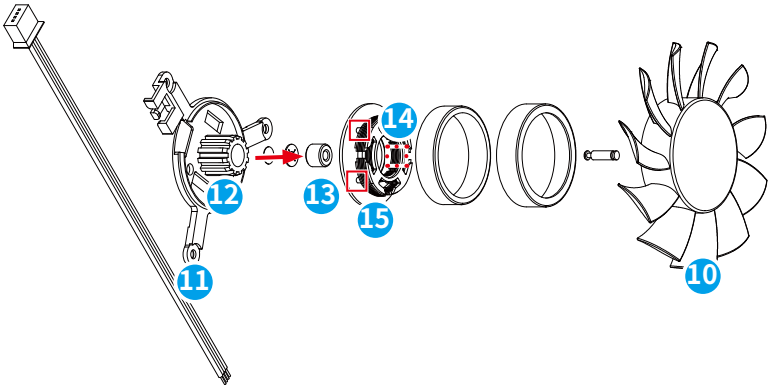
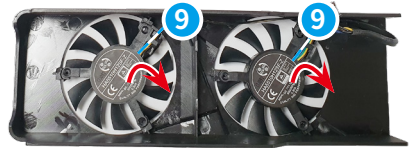
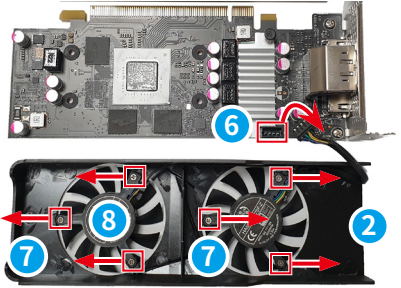
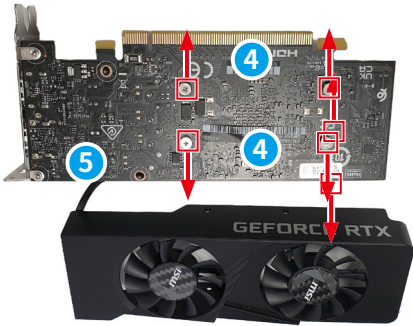
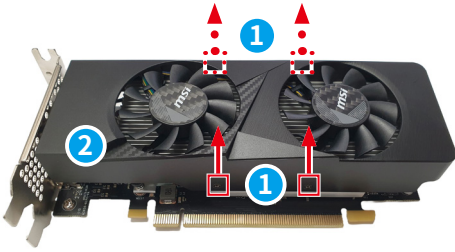

## Internal Power Supply (IPS)

---

1. Follow [Internal Power Supply \(IPS\) Disassembly](#) to remove the IPS from the mainboard.
  2. Use a cross-head screwdriver to loosen and remove screws ① at both side of the IPS cover, and screws ② that secure the fan. Open the IPS cover, cut the fan cable ③ and side cables ④ with diagonal pliers, remove screws to release the IPS PCB ⑥, then take out the fan ⑦ by hand.
  3. Cut the joints ⑧ and blade edges ⑨ with diagonal pliers to separate the fan blades ⑩ and frame ⑪, and remove metal parts. Pry out the magnetic bar ⑫ to uncover the fan PCB ⑬ using a parallel screwdriver. Cut the PCB-to-motor pins ⑭ with diagonal pliers, then remove the PCB.
  4. Please recycle IPS PCB ⑥, fan blades ⑩, fan frame ⑪, and fan PCB ⑬ to qualified recyclers.
-

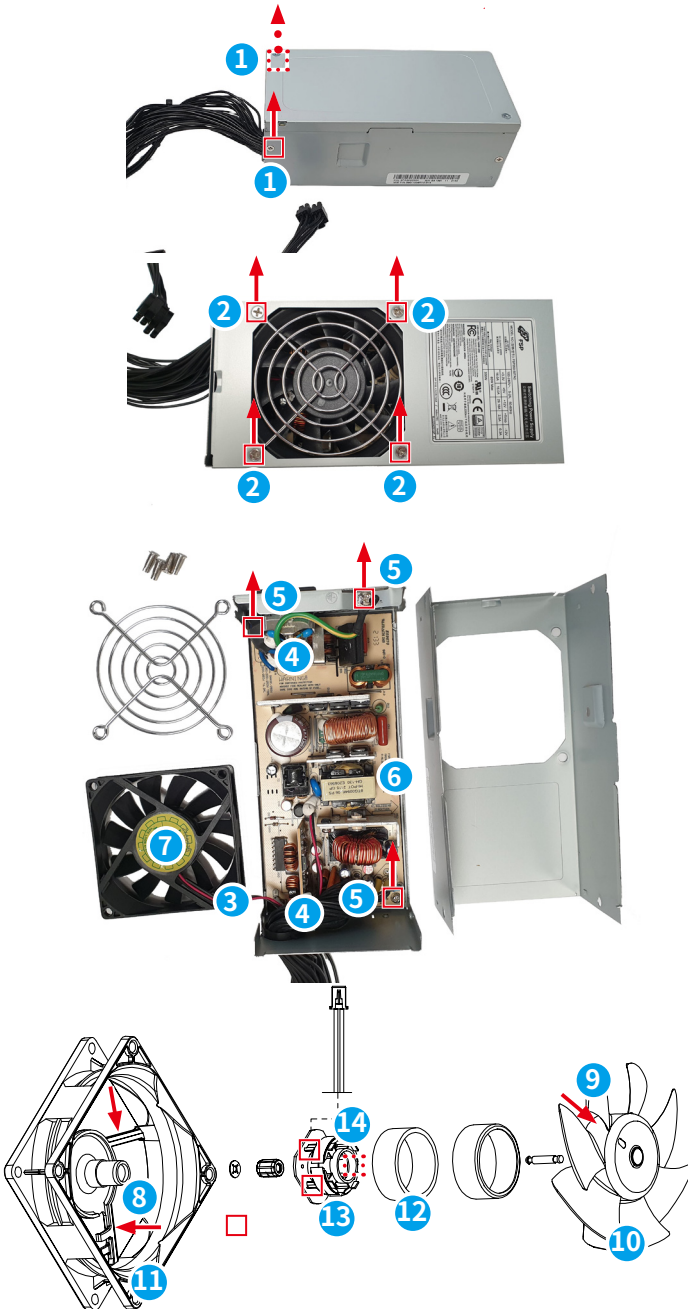

## Wired Mouse (Optional)

---

1. Refer to [Wired Mouse Disassembly](#) to disassemble the wired mouse.
  2. Please recycle the top case [3](#), key plate [4](#), bottom case [5](#) and wired mouse USB cable [8](#) to qualified recyclers.
- 

## Wired Keyboard (Optional)

---

1. Refer to [Wired Keyboard Disassembly](#) to disassemble the wired keyboard.
  2. Please recycle the top case [2](#), bottom case [8](#) and wired keyboard USB cable [5](#) to qualified recyclers.
-

# Product End-of-Life Instructions



**Important**

## MSI Environmental Information

Information on MSI’s Environmental initiatives, policies, programs and goals can be found at [Environmental Sustainability Policy](#).

## Purpose

This information is to provide the guidance to recyclers on the presence of materials and components at the product level, as required by the EU WEEE and amending Directive.

## Information on Component and Material Identification

The following substances, preparations, or components should be disposed of or recovered separately from other WEEE in compliance with Article 4 of EU Council Directive 75/442/EEC.

Identify materials for materials and components of the waste electrical and electronic equipment list.

\*1: The following item numbers correspond with those in [Product Components and Accessories](#).

| Materials   | Item*1               | Location                       |
|---|----------------------|--------------------------------|
| Polychlorinated biphenyl (PCB) containing capacitors and all polychlorinated biphenyls and polychlorinated terphenyls (PCB/PCT) containing electrical equipment | —                    | Absent                         |
| Mercury containing components, such as switches or backlighting lamps   | —                    | Absent                         |
| Batteries   | <a href="#">16</a>   | Battery                        |
| Printed circuit boards of mobile phones generally, and of other devices if the surface of the printed circuit board is greater than 10 square centimeters       | <a href="#">44</a>   | Graphics Card                  |
|   | <a href="#">43</a>   | Thermal Module                 |
|   | <a href="#">18</a>   | TPM Module                     |
|   | <a href="#">19</a>   | Mainboard                      |
|   | <a href="#">20</a>   | Internal Power Supply Main PCB |
|   | <a href="#">22-1</a> | Wired Mouse PCB                |
|   | <a href="#">23-1</a> | Wired Keyboard PCB             |

| Materials   | Item*1               | Location                       |
|---|----------------------|--------------------------------|
| Toner cartridges, liquid and paste, as well as color toner  | —                    | Absent                         |
| Plastic containing abominated flame retardants  | <a href="#">2</a>    | Front Bezel                    |
|   | <a href="#">6</a>    | ODD Cover                      |
|   | <a href="#">10</a>   | Graphics Card                  |
|   | <a href="#">43</a>   | Thermal Module                 |
|   | <a href="#">20</a>   | Internal Power Supply          |
|   | <a href="#">22</a>   | Wired Mouse                    |
|   | <a href="#">23</a>   | Wired Keyboard                 |
| Asbestos waste and components which contain asbestos  | —                    | Absent                         |
| Cathode ray tubes   | —                    | Absent                         |
| Chlorofluorocarbons (CFC), Hydrochlorofluorocarbons (HCFC) or Hydrofluorocarbons (HFC), Hydrocarbons (HC)   | —                    | Absent                         |
| Gas discharge lamps   | —                    | Absent                         |
| Liquid crystal displays (together with their casing where appropriate) of a surface greater than 100 square centimeters and all those back-lighted with gas discharge lamps | —                    | Absent                         |
| External electric cables  | <a href="#">21</a>   | Power Cord                     |
|   | <a href="#">22-2</a> | Wired Mouse USB Cable          |
|   | <a href="#">23-2</a> | Wired Keyboard USB Cable       |
| Components containing refractory ceramic fibers   | —                    | Absent                         |
| Components containing radioactive substances, or materials that become radioactive  | —                    | Absent                         |
| Electrolytic capacitors containing substances of concern (height > 25 mm, diameter > 25 mm or proportionately similar volume)   | <a href="#">20</a>   | Internal Power Supply Main PCB |
| Beryllium and its compounds (including Beryllium Oxide)   | —                    | Absent                         |
| Liquids   | —                    | Absent                         |

## Product Take-Back Service

Waste electrical equipment may contain hazardous substances and thus endanger human health & the environment. Proper disposal is therefore required. MSI provides free recycling of EPEAT-registered products to ensure that the product reaches the end of its useful life and that it is recycled responsibly.

To properly recycle your equipment through this service, please follow the steps:

1. Please delete your personal data from your waste equipment.
2. [CLICK HERE](#) to learn how to recycle your end-of-life product.
3. Find the MSI recycling location nearby on the website.
4. Contact the designated recycling location by phone or email to schedule your pickup. The customers are responsible for any shipping and delivery charges.



# Using MSI Center

# Login and Register

Before using MSI Center, it is recommended that you create your own account and register your MSI product to get full benefits from MSI Center at once.

## Create an Account

1. Make sure the Internet connection works properly.
2. Activate MSI Center. Click the profile icon at the upper right corner and click [Login].

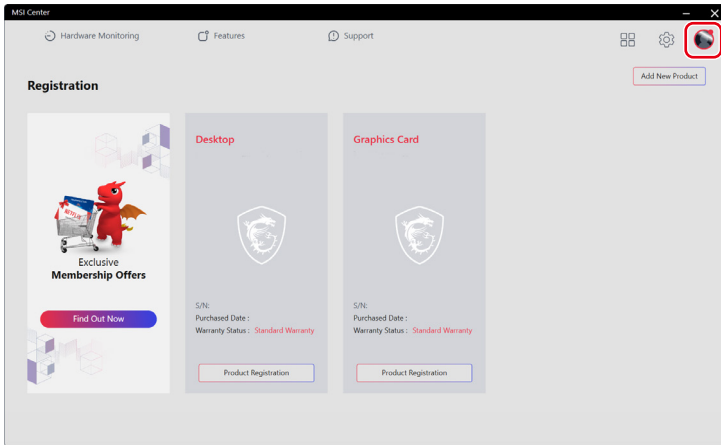

3. Select [Join MSI Member].

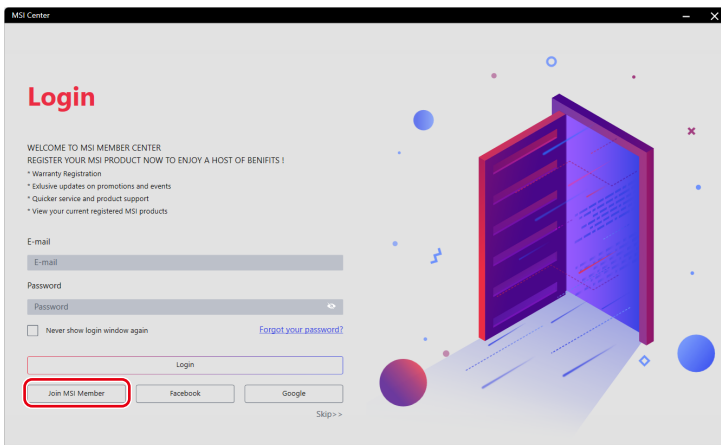

4. Follow the on-screen instructions to create a personal account.

The screenshot shows the 'CREATE AN ACCOUNT' form in the MSI Center application. The form includes the following fields and options:

- E-mail:** A text input field with the placeholder text 'Please enter your email'.
- Password:** A text input field with the placeholder text 'Please create a new password for MSI Center account'.
- Confirm Password:** A text input field with the placeholder text 'Repeat the password entered above'.
- Name:** Two text input fields for 'Please enter your first name' and 'Please enter your last name'.
- Date of Birth:** Three dropdown menus for selecting the day, month, and year.
- Region/Location:** A dropdown menu for selecting the region.
- Agreement:** A checkbox followed by the text 'I agree to the MSI Member Center and MSI Online Shop Terms and Conditions.' with links to 'MSI Member Center' and 'MSI Online Shop'.
- Navigation:** 'Prev' and 'Next' buttons at the bottom right.

## Product Registration

Once a personal account is created, you may log in and start to register your products.

1. MSI Center will automatically detect your MSI devices. Click [Product Registration] and follow the on-screen instructions to complete the registration.
2. To register more MSI multimedia accessories connected to your system, click [Add New Product] and follow the on-screen instructions to add and register your accessories.

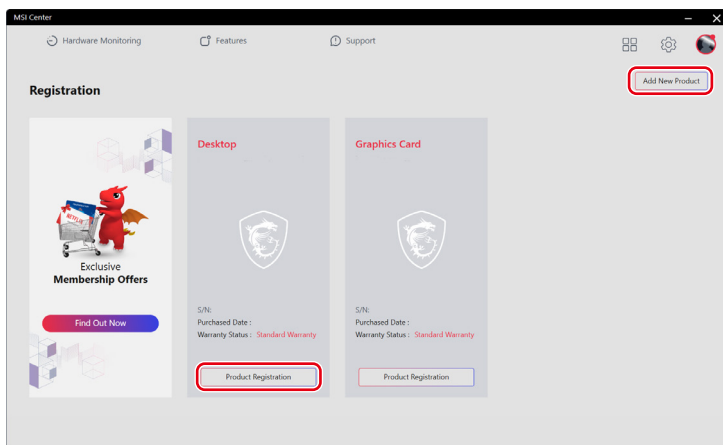

# Feature Sets

Users can download, update or uninstall MSI exclusive features in Feature Sets.

1. Click the [Feature Sets] icon at the upper right corner.
2. Install or uninstall any MSI features to meet your personal needs.

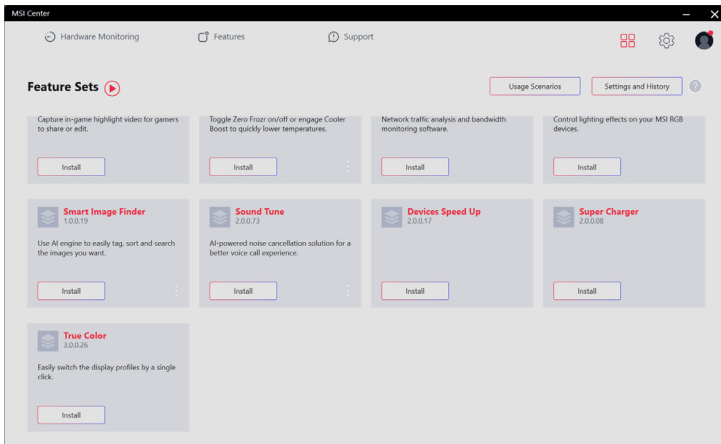
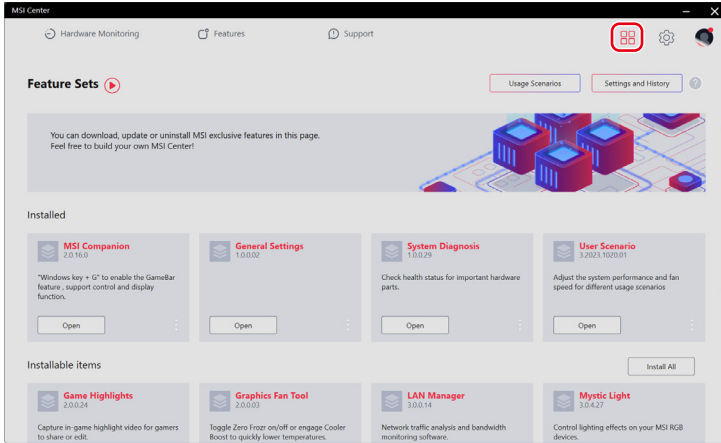

# Hardware Monitoring

Hardware Monitoring provides real-time status of the CPU, GPU, memory, fans, etc. Click [Free Up Memory] to release system memory that is no longer required.

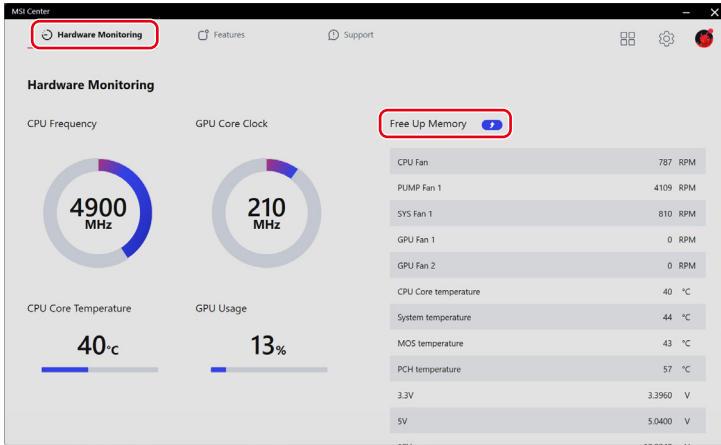

# Features

[Features] will vary depending on the features users have installed through [Feature Sets].

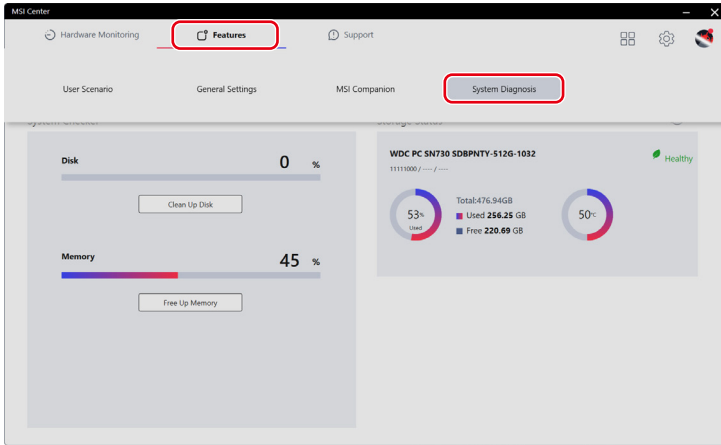

# System Diagnosis

[System Diagnosis] provides [System Checker] for users to clean up their hard drives and free up system memory while [Storage Status] helps users keep their storage health in check.

- To clean up the storage, click [Clean Up Disk], select the drive you want to clean up from the pop-up menu, and follow the on-screen instructions to clean up the storage.
- To free up memory, click [Free Up Memory] and MSI Center will instantly release system memory that is no longer required.

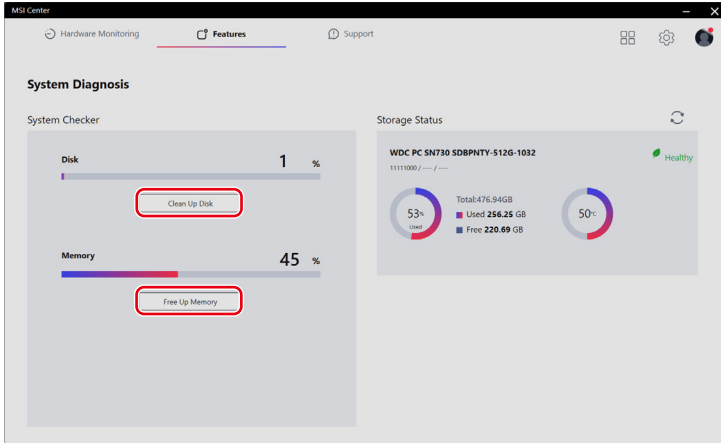

# Support

Support offers various customer support channels to fulfill the needs of every user.

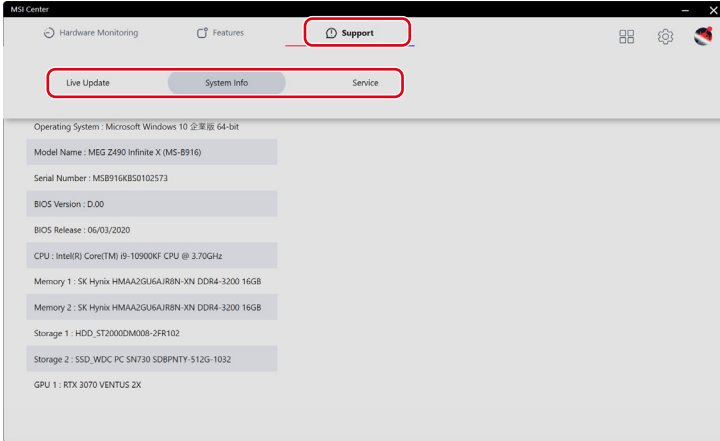

## Live Update

### Live Update

It is recommended that users click [Scan] under [Live Update] to get the latest MSI or third-party utilities for update.

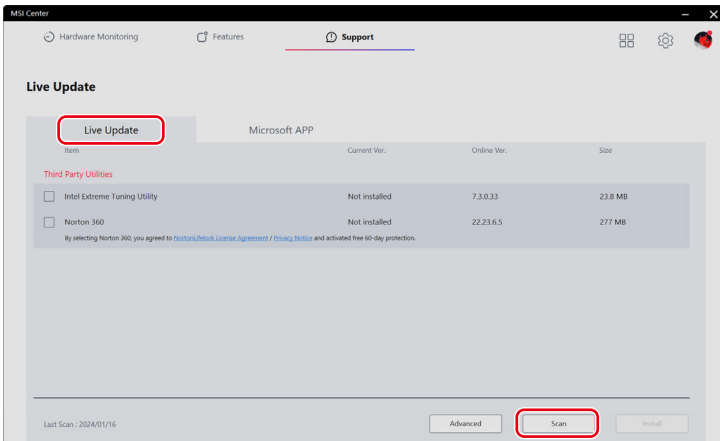

## Microsoft APP

When using this function for the very first time, analyzing the system with Live Update is a must.

1. Click [Scan] under [Live Update].
2. Click [Microsoft APP] where a list of compatible applications on Microsoft Store are displayed.
3. Select a desired application and follow the on-screen instructions to install the application.

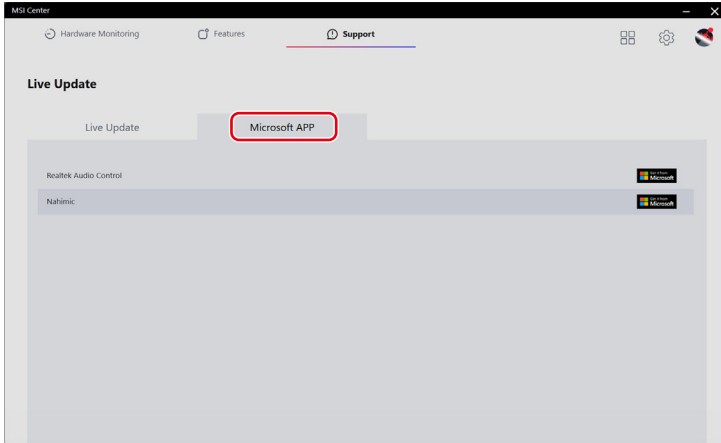

## System Info

System Info shows read-only system information.

- [Export System Info]: Exporting the current system information data to a .txt file.
- [Scan]: Scanning the system for the latest information.

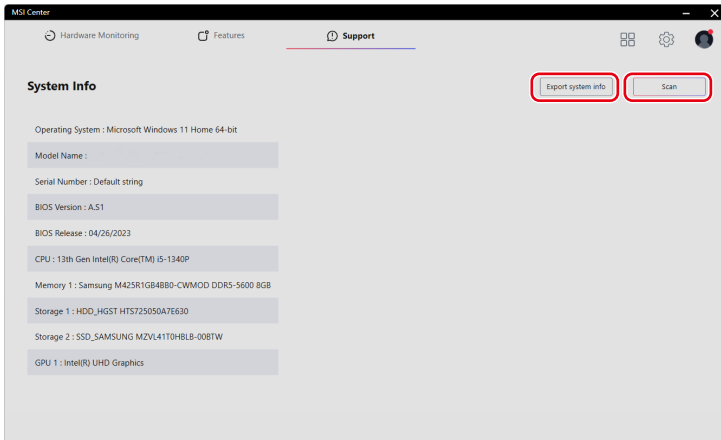

# Service

## Forum & Channel

- [MSI Forum]: Directing users to MSI Global Forum for discussion with global users.
- [How-To Channel]: Directing users to MSI HOW-TO CHANNEL for guides, tips & tricks that help you get more from your MSI products.

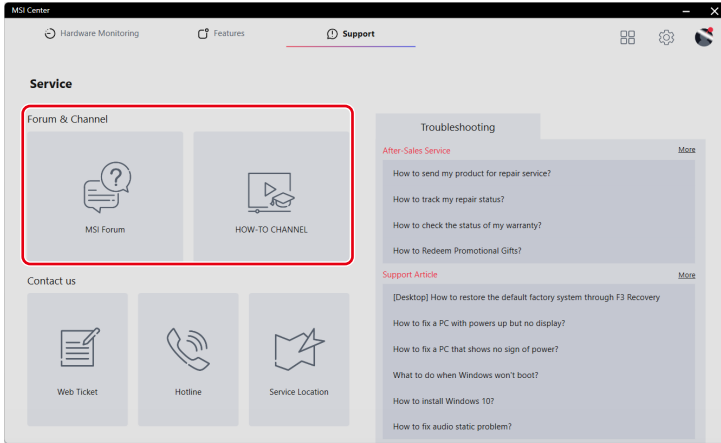

## Contact Us

Users may contact MSI via the following channels.

- Click [Web Ticket] to reach MSI Member Center.
- Click [Hotline] to talk to a service representative.
- Click [Service Location] to locate a nearby repair service shop.

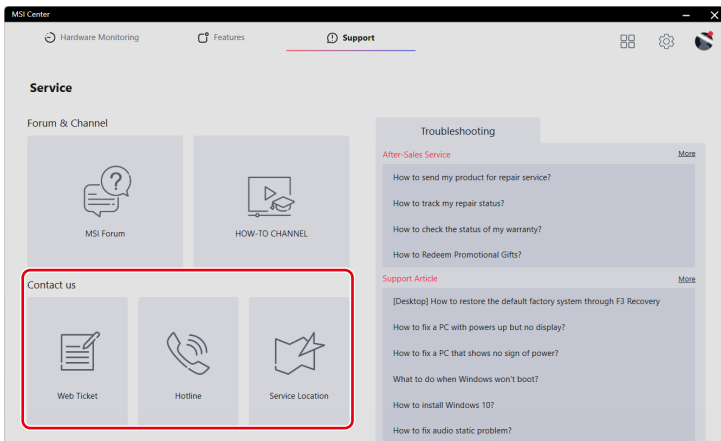

# Troubleshooting

- [After-Sales Service]: Providing instructions on repair, warranty and other after-sales services.
- [Support Article]: Offering advice on how to troubleshoot your MSI products.

If further assistance is needed, click [More] for MSI online service and support.

