



PRO Series

LCD Monitor

PRO MP245PG E14
PRO MP245PGDE E14

Service Guide

Contents

Copyright and Trademarks Notice.....	4
Revision	4
How to Use this Service Guide	4
Safety Instructions	5
Power.....	5
Environment.....	5
Conditional Warranty Service.....	6
Upgrade and Service.....	6
Publicly Available Service Information	7
Disassembly & Assembly.....	9
Product Components and Accessories	10
Product Upgradeability and Repairability	12
Recommended Tools	13
Screw List	13
Preparation for Disassembly	14
The Stand	16
Stand Disassembly.....	16
Stand Assembly	17
Rear Cover	18
Rear Cover Disassembly.....	18
Rear Cover Assembly	20
Navi Board & Navi Key.....	24
Navi Board & Navi Key Disassembly	24
Navi Board & Navi Key Assembly	25
Speakers	26
Speaker Disassembly.....	26
Speaker Assembly	27

LCD Panel & Shielding Cover	28
LCD Panel & Shielding Cover Disassembly.....	28
LCD Panel & Shielding Cover Assembly	29
Mainboard	30
Mainboard Disassembly.....	30
Mainboard Assembly	31
Power Board.....	32
Power Board Disassembly.....	32
Power Board Assembly.....	33
Deco Strip.....	34
Deco Strip Disassembly	34
Deco Strip Assembly	35
Powering Up After Maintenance	36
Troubleshooting	37
Recycling Guidelines	38
Stand base.....	38
Both plates.....	39
VESA plate.....	40
Stand enclosure	41
Rear Cover.....	43
Removal of Deco Strip & LCD Bezel	44
Product End-of-Life Instructions	47
Purpose	47
Information on Component and Material Identification	47
Product Take-Back Service.....	48
OSD Setup	50
OSD Setup.....	50
OSD Menu	51
Image.....	54
Input Source	55
PIP/PBP	56
Navi Key.....	57
Settings.....	57

Copyright and Trademarks Notice

Copyright © 2023 Micro-Star Int'l Co., Ltd. All rights reserved.

The MSI logo used is a registered trademark of Micro-Star Int'l Co., Ltd. Third-party trademarks and names are the properties of their respective owners. No warranty as to accuracy or completeness is expressed or implied. MSI reserves the right to make changes to this document without prior notice.

Revision

V1.0,2025/04

How to Use this Service Guide

This Service Guide provides in-depth illustration of disassembling/assembling the product. Since the topics in this guide may be related, it is recommended that you read it from cover to cover first. After that, you may go directly to any specific topic that most meets your immediate needs.

Safety Instructions

Adhere to safety precautions when handling the product to prevent harm or damage to individuals or the product's functionality.

Power

- If the power cord comes with a 3-pin plug, do not disable the protective earth pin from the plug. The monitor must be connected to an earthed mains socket-outlet.
- Disconnect all power sources and place the product on a steady surface before disassembly/assembly.
- When unplugging the power cord, always hold the connector part of the cord. Never pull the cord directly.
- Place the power cord in a way that people are unlikely to step on it. Do not place anything on top of the power cord.
- If this product comes with an adapter, use only the MSI provided AC adapter approved for use with this product.

Environment

- Do not place the product in environments subject to mist, smoke, vibration, excessive dust, salty or greasy air, or other corrosive gases and fumes.
- To avoid electrostatic discharge, use an anti-static wrist strap before handling components. Always handle electrostatic-sensitive components, parts, and assemblies only at static-free work areas.
- Handle components with care. Do not touch the pins or contacts on a component.
- Place components on a grounded anti-static pad or on the bed that came with the components whenever the components are separated from the product.
- Handle the display panel with extra care as it is fragile and could break.
- Do not perform any maintenance with wet hands.
- Prevent foreign substances, such as water, other liquids or chemicals, from entering the product while performing disassembly/assembly.
- After assembly, ensure that all screws are replaced and no stray screws remain inside the product.

Conditional Warranty Service

MSI provides a conditional warranty service for selected models. Please visit [MSI Member Center](#) for further information.

Upgrade and Service

Available hardware features may only be offered as part of an upgrade, repair, or replacement service offered by MSI or an authorized service provider.

MSI offers customers replacement parts, product repair and services for 3 years from the date of sale for all EPEAT-registered products.

Damages caused by servicing of products not authorized by MSI or the use of modified or non-MSI authorized parts or components are not covered by MSI Limited Warranty Agreement.

Visit [MSI Service Location](#) to obtain these services offered by MSI.

Go to [MSI Web Ticket](#) to receive further assistance if needed.

Publicly Available Service Information

Service Information	Section
Disassembly instructions including identifying the required tools.	<u>Product Components and Accessories</u> <u>Recommended Tools</u>
Exploded diagram of parts.	<u>Product Components and Accessories</u>
List of spare parts including manufacturer-approved spare parts and how to obtain them.	<u>Product Upgradeability and Repairability</u>
Maintenance procedures or guidance on where to obtain the procedures.	<u>Monitor Support</u> <u>OSD Setup</u>
Troubleshooting instructions, software diagnostic tools, troubleshooting videos or other troubleshooting guidance.	<u>Troubleshooting</u>
Instructions on how to obtain software updates (not applicable to display products).	N/A
Instructions on how the user can remove personal data. If the instructions require destruction of the storage, instructions to replace the storage shall be provided (not applicable to display products).	N/A

It is acceptable for service instructions to exclude information that, as determined by the manufacturer:	
a) May expose the user to risk of injury, or	N/A
b) Breaches intellectual property rights, or	N/A
c) Compromises user privacy or security, or	N/A
d) Involves the disassembly of a battery pack or power supply	N/A
If claiming any of the four exclusions above the manufacturer shall demonstrate how the product is restored to normal operating condition after being repaired. Repair may include replacement of the component(s) associated with the exclusion.	N/A

Disassembly & Assembly

Product Components and Accessories



MSI provides the below list of components for the system configuration purchased and within 2 years after discontinuation of the product to increase the operational life of that product. Further services can be obtained by contacting [MSI Online Customer Service](#)

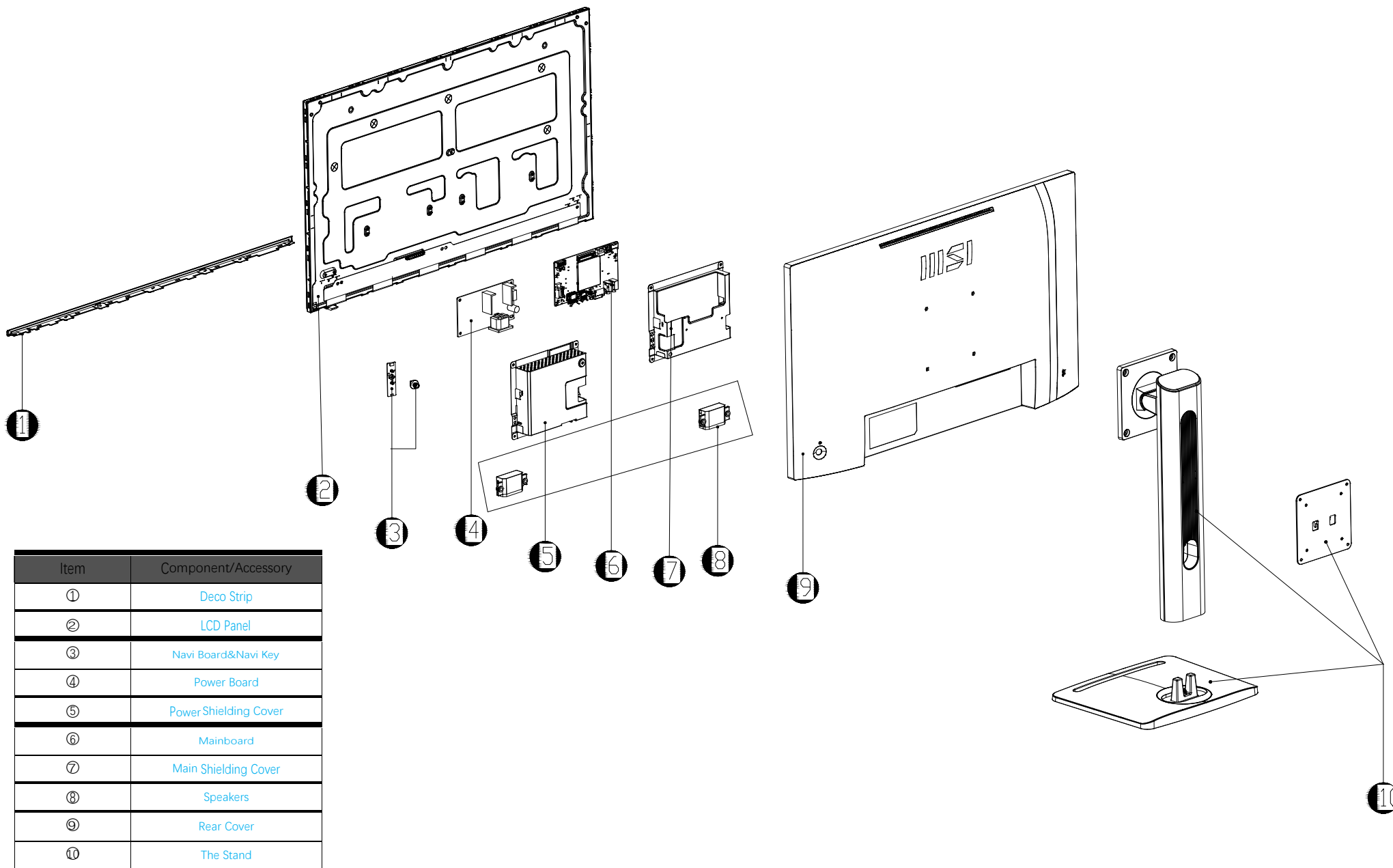

Item	Component/Accessory
①	Deco Strip
②	LCD Panel
③	Navi Board&Navi Key
④	Power Board
⑤	Power Shielding Cover
⑥	Mainboard
⑦	Main Shielding Cover
⑧	Speakers
⑨	Rear Cover
⑩	The Stand

Product Upgradeability and Repairability

Hardware features for upgradeable, repairable or replaceable using only commonly available tools and listing of replaceable spare parts by products can be obtained by contacting [MSI Online Customer Service](#).

For replacement, repair, or upgrade methods, please refer to the [hyperlinks](#) in the table below.

Hardware feature items	Upgradeable	Repairable	Replaceable	Soldering
The main processor(s) or system on a chip (SOC)	No	No	No	Yes
The main memory capacity of the system	No	N/A	N/A	N/A
Mass storage capacity of the system	N/A	N/A	N/A	N/A
Wireless networking capability	N/A	N/A	N/A	N/A
Graphics capability (integrated or discrete)	N/A	N/A	N/A	N/A
Display panel or display assembly	N/A	No	Yes	No
Integrated mechanical keyboards	N/A	N/A	N/A	N/A
All batteries	N/A	N/A	N/A	N/A
All external and internal power supplies	N/A	No	Yes	No
All fan assemblies	N/A	N/A	N/A	N/A
AND At least two of the following (or one, if all remaining are absent from product):	Upgradeable	Repairable	Replaceable	Soldering
Speakers	No	No	Yes	No
Camera	No	No	No	No
Touchpad	N/A	N/A	N/A	N/A
I/O connectors and external power connection	No	No	No	Yes
Readers (eg. magnetic stripe, Dallas key, fingerprint, Smart card)	N/A	N/A	N/A	No

Recommended Tools

The following tools may be needed while performing the disassembly and assembly procedures.

- Cross-head screwdriver
- Parallel screwdriver (optional)
- Tweezers
- Pry tool
- Diagonal pliers (optional)
- Heat gun (optional)
- Anti-static gloves
- Anti-static wrist strap (optional)
- Anti-static mat with grounding wire (optional)
- Anti-static wrist strap (optional)

Screw List

Please refer to the screw list below while proceeding the disassembly and assembly of the computer.

Note: This screw list is for reference only and may vary from models to models. It is highly recommended that users contact the authorized service center for further assistance.

Component	Screw Type	Quantity
Deco strip	M2.5*4	5
Power Board	M3*6	4
Shielding Cover	M3*3	4
Mainboard	M3*6	4

Preparation for Disassembly

1. Power off the monitor and your computer.
2. Disconnect the power cords of your monitor and PC from the electrical outlet.
3. Disconnect the all cables power cord from the monitor.

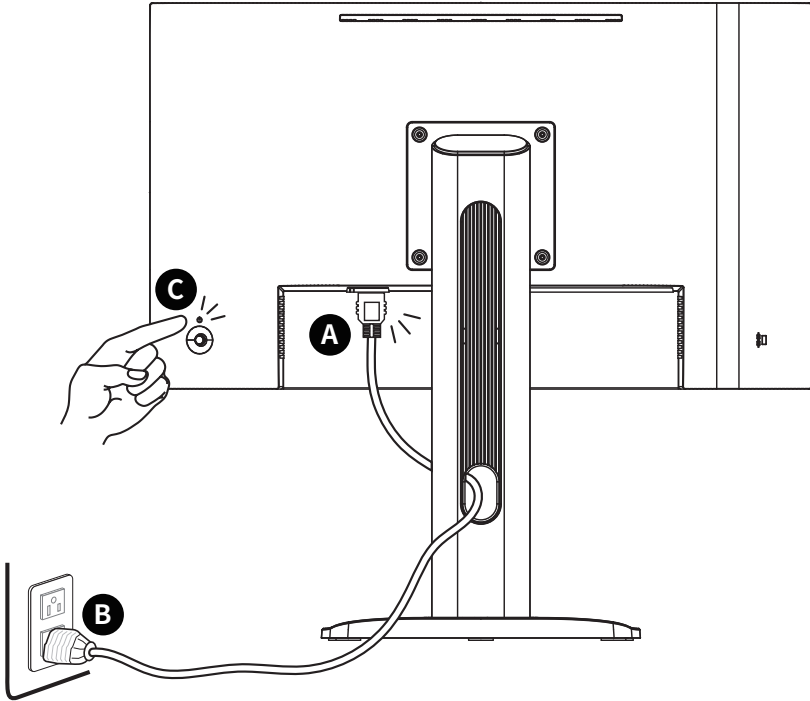

 **Important**

- *Disconnect all power sources and place the monitor on a steady surface before disassembly/assembly.*
- *When unplugging the power cord, always hold the connector part of the cord. Never pull the cord directly.*
- *Do not place the monitor in environments subject to mist, smoke, vibration, excessive dust, salty or greasy air, or other corrosive gases and fumes.*
- *To avoid electrostatic discharge, use an anti-static wrist strap before handling electrostatic-sensitive components.*
- *Handle the display panel with extra care as it is fragile and could break.*
- *Do not perform any maintenance with wet hands.*
- *After assembly, ensure that all screws are replaced and no stray screws remain inside the monitor.*

The Stand

Stand Disassembly

1. Place the monitor face down on a steady, protected surface.
2. Locate and remove the screws that secure the stand **1**.
3. Lift up and remove the stand **2** from the monitor.



Stand Assembly

1. Place the monitor face down on a steady, protected surface.
2. Align the screw holes on the stand with the screw holes on the rear cover.
3. Replace and fasten the screws **1** to secure the stand **2**.



Rear Cover

Rear Cover Disassembly

1. Place your thumbs on the rear cover **1**, and other fingers **2** against the front bezel. Press down your thumbs **3** to open top, left and right side of the rear cover.

 **Important**

- Avoid finger pressure on the screen surface, it may damage the display.
-



2. Use a pry tool to carefully pry off the bottom side of the rear cover.



3. Gently lift the rear cover up ④ and be careful when disconnecting speaker cables ⑤.

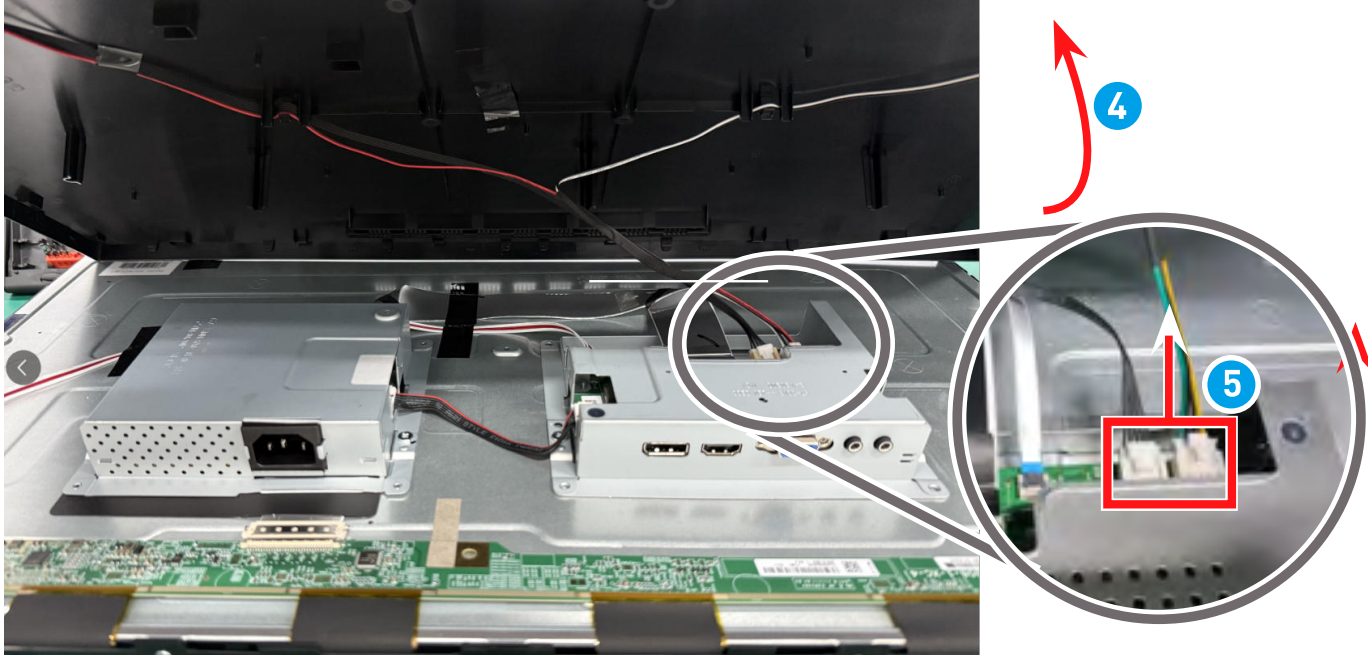

4. Gently deroute and remove the Navi board ⑥, speakers ⑦, and all cables from the rear cover.

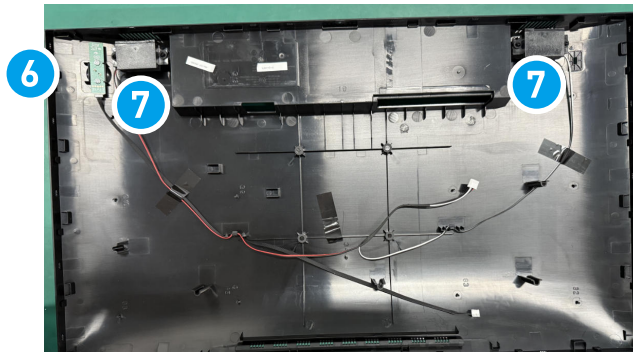

5. Remove Navi Key to complete.

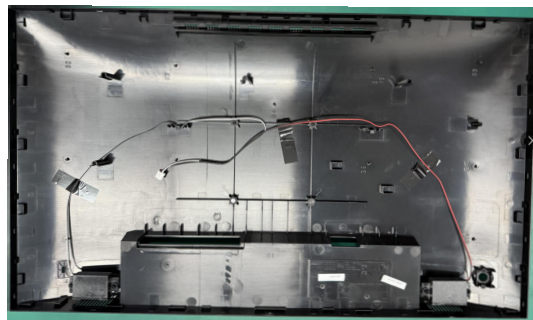

Rear Cover Assembly

1. Insert Navi Key to start assembling the rear cover.

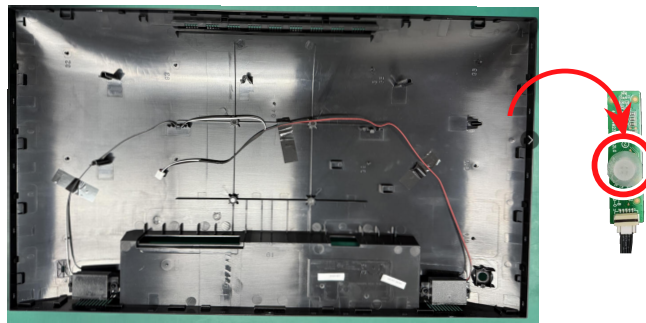

2. Carefully attach the Navi Board **1**, speakers **2** to its position and route their cables.

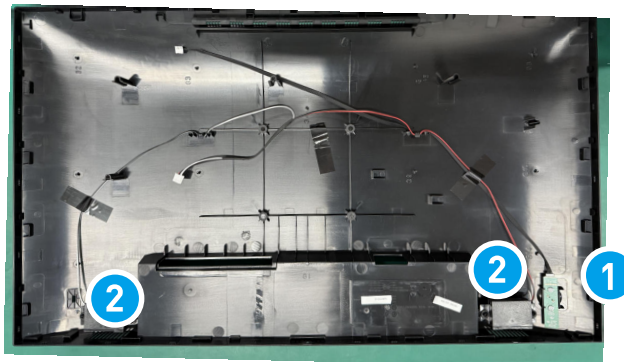

3. Connect speaker cables **3** to the mainboard carefully, then close the rear cover **4**.

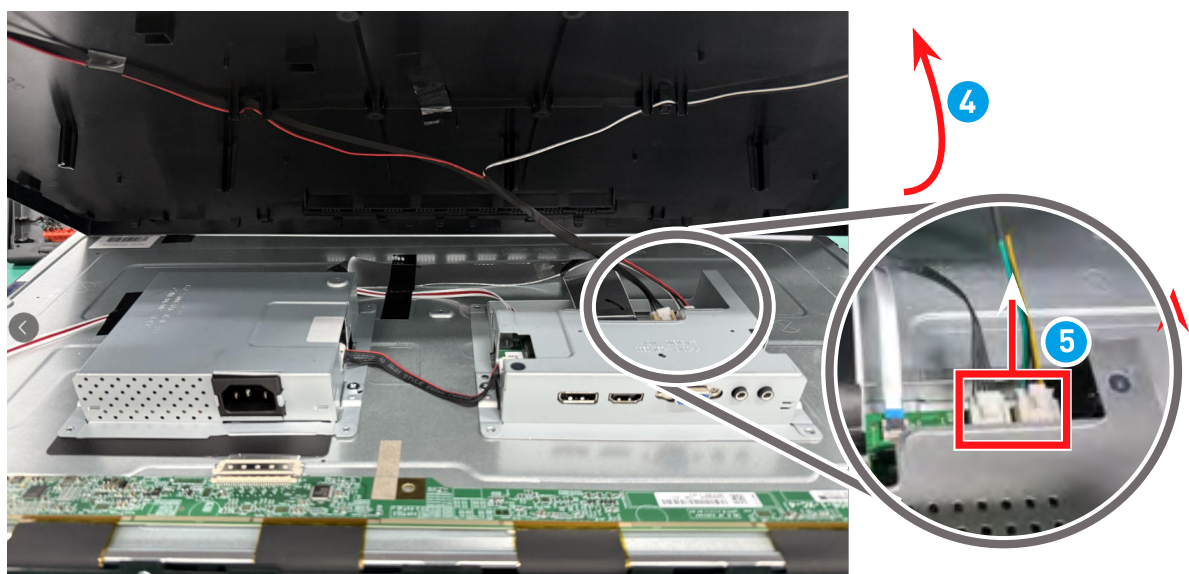

-
4. Align the tabs on the rear cover with the slots **5**. Gently push the rear cover downwards **6** to finish.

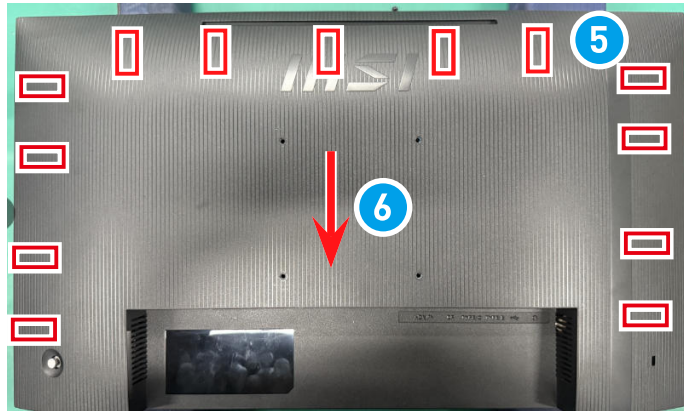

Navi Board & Navi Key

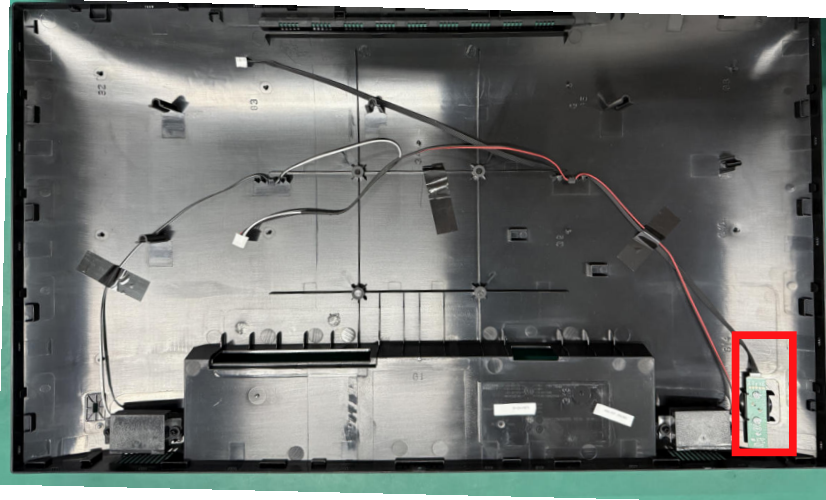

Navi Board & Navi Key Disassembly

1. Lift and remove the Navi board **1** with the cable off the rear cover.

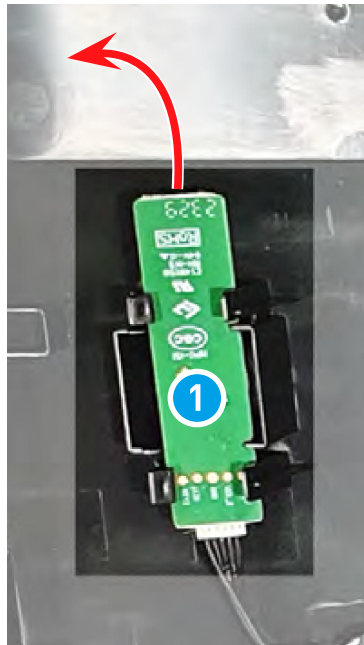

2. Remove Navi Key **2** to clear the rear cover.

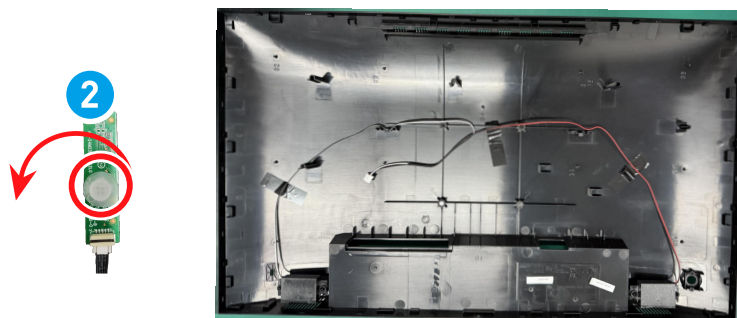

Navi Board & Navi Key Assembly

1. Insert Navi Key **1** to start assembling the rear cover.

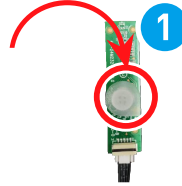
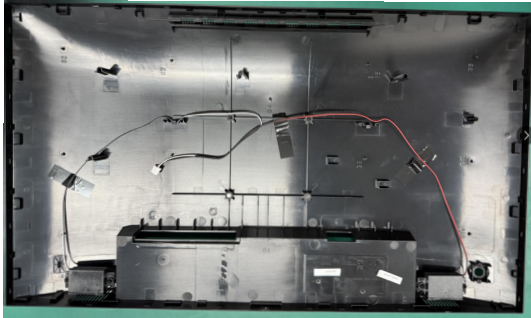

2. Align and replace the Navi key board **2** onto the rear cover.

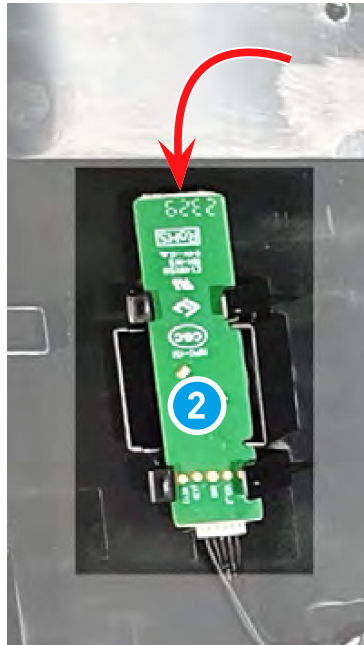

Speakers

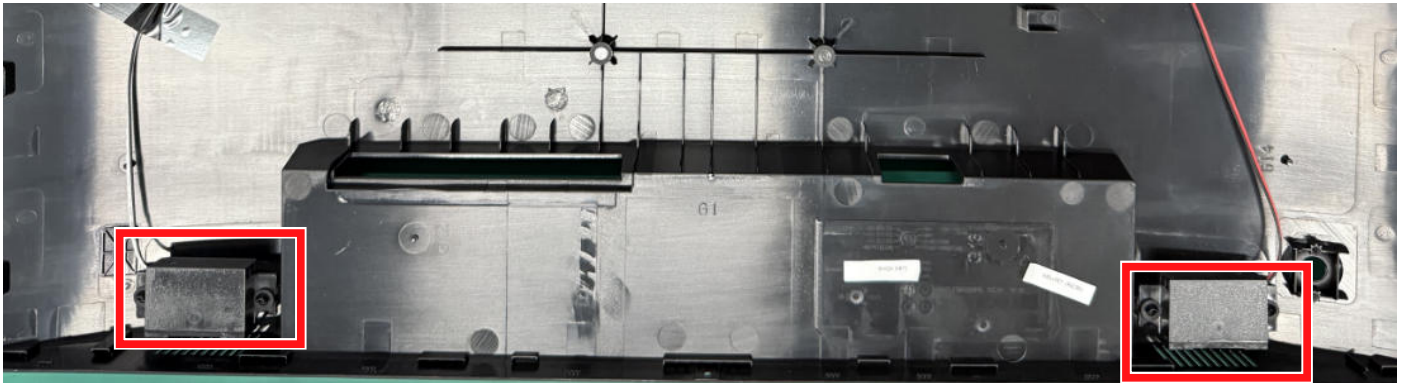

Speaker Disassembly

1. Locate speakers.



2. Disassemble speakers from the retainers **1** and carefully deroute speaker cables.

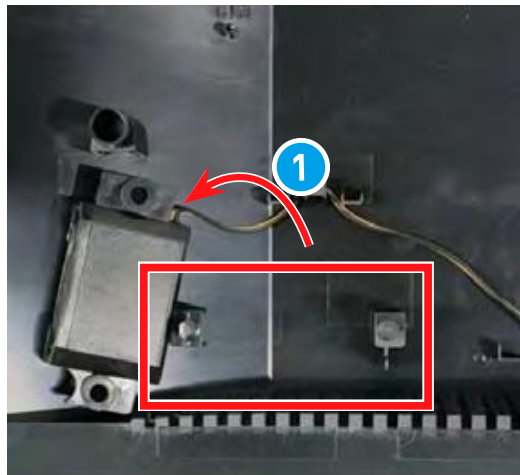

Speaker Assembly

1. Align speaker cables and secure speakers to retainers ①.

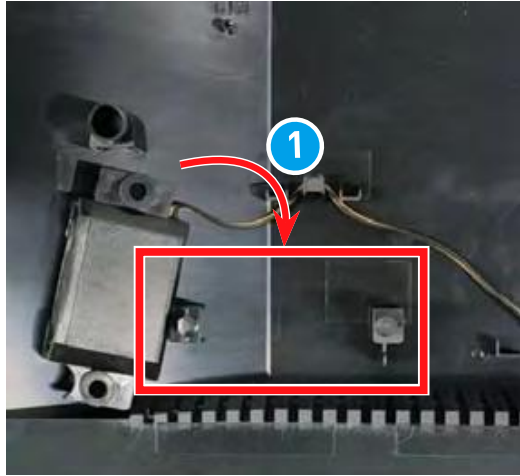

-
2. Route and connect the speaker cables.



LCD Panel & Shielding Cover



LCD Panel & Shielding Cover Disassembly

1. Remove shielding cover screws **1** and deco strip screws **2**.

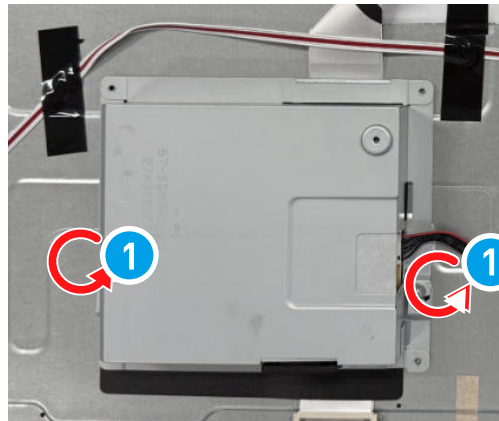

2. Disconnect the LED cable **3**. And disconnecting the panel signal cable **4**.

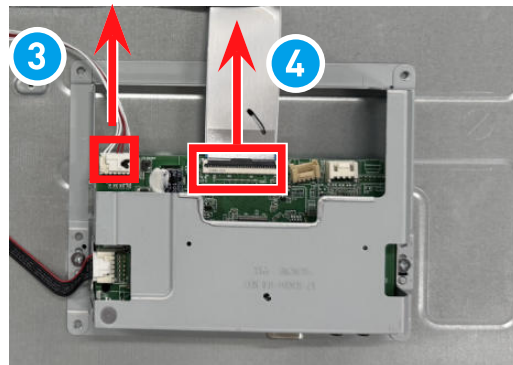

3. Remove the shielding cover **6**, panel signal cable **7**, LED cable **8**,

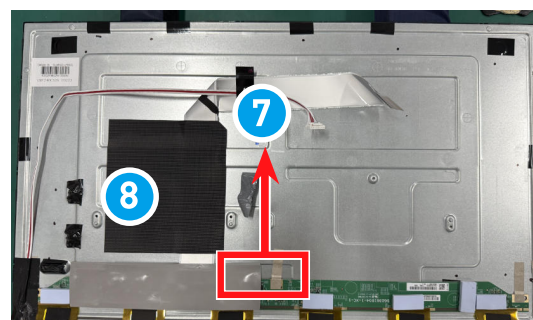
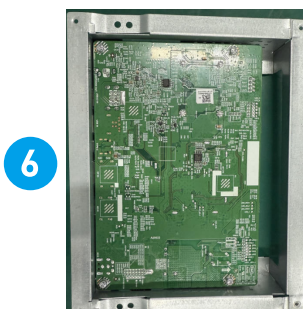

LCD Panel & Shielding Cover Assembly

1. connect panel signal cable ②

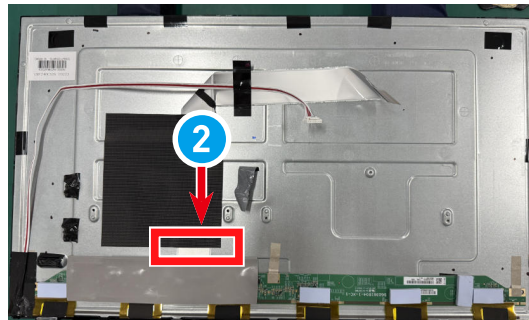

2. Connect the panel signal cable ⑤, press and hold the cable's release tabs and pull the cable carefully inwards. Connect the LED cable ⑥ at both ends and ⑦ remember to wrap the LED cable in the left corner of LCD panel in black tape to prevent light leakage

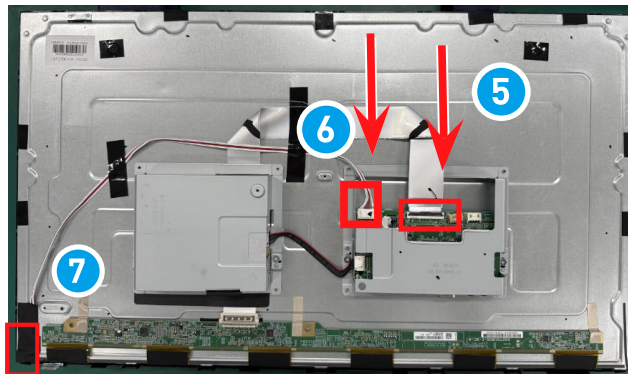

3. Secure the deco strip screws ⑨, shielding cover screws ⑩ to complete.

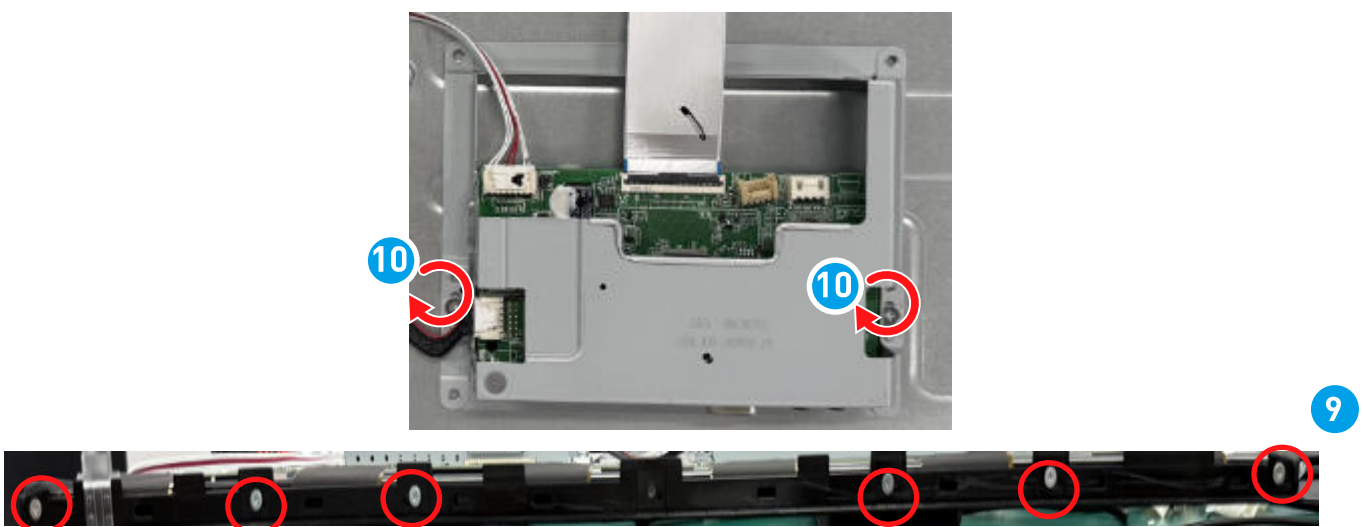

Mainboard

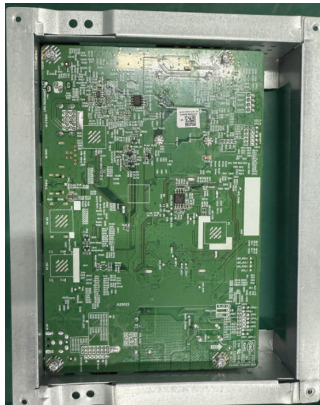

Mainboard Disassembly

Follow [LCD Panel & Shielding Cover Disassembly](#) to remove the mainboard.

1. Locate the mainboard, remove screws. ①
2. Disconnect the cable from the left mainboard ② to finish.

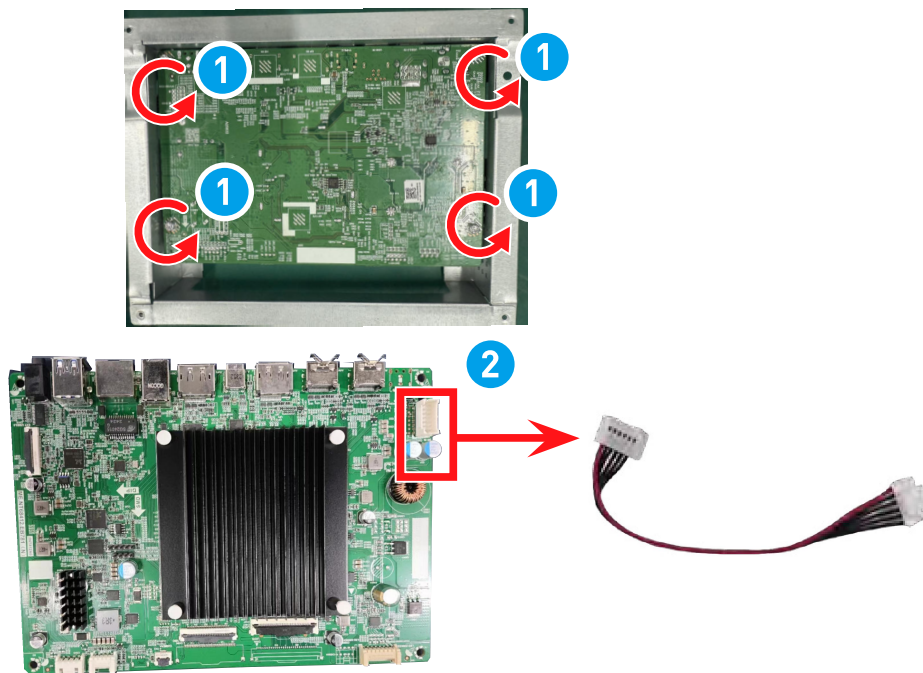

Mainboard Assembly

1. Connect the cable from the left mainboard **1** to finish.
2. Locate the mainboard, remove screws. **2**

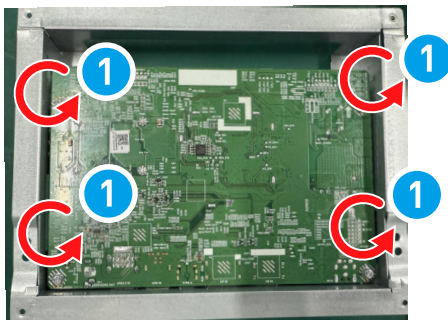
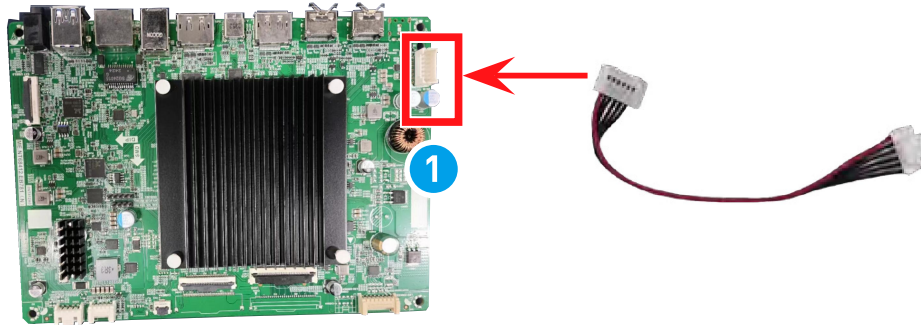

Power Board



Power Board Disassembly

Follow [LCD Panel & Shielding Cover Disassembly](#) to remove the powerboard.

1. Unscrew the screws on the power board. ①
2. Disconnect the cable from the right powerboard ③ to finish.

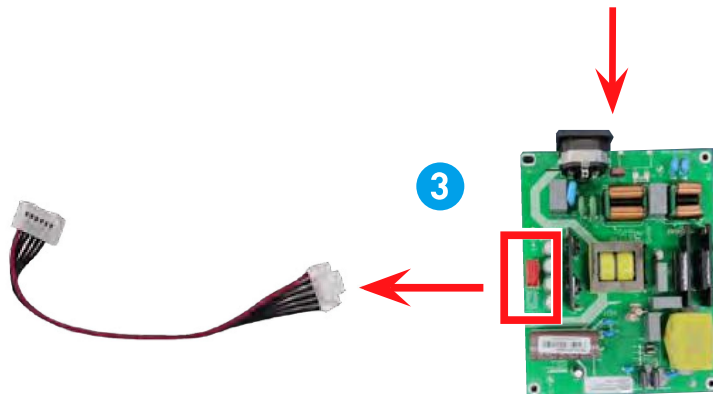
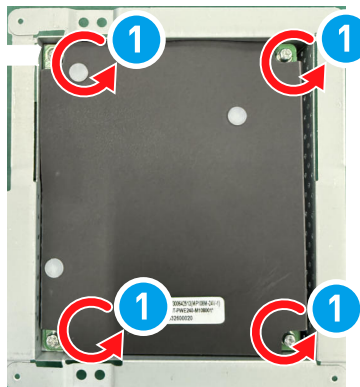

Power Board Assembly

1. Connect the cable from the right powerboard **1** to finish.

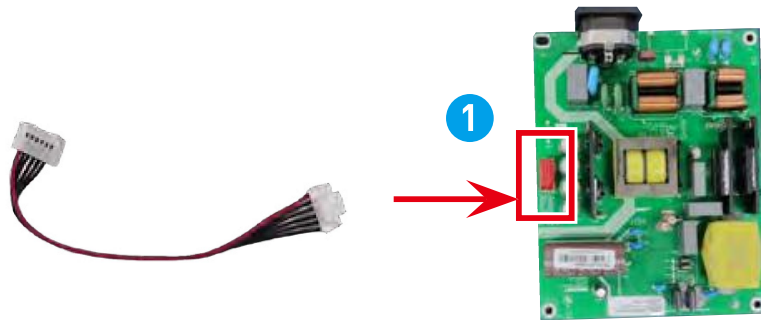

Deco Strip



Deco Strip Disassembly

1. Follow [LCD Panel & Shielding Cover Disassembly](#) to remove the Deco Strip.
2. Place the monitor in face-down position. Remove screws **1** that secure the deco strip to the LCD bezel with a cross-head screwdriver.

1

-
3. With the monitor face up, Gently pull outwards to remove the deco strip **2** from the LCD bezel.



Deco Strip Assembly

1. Place the deco strip **1** back to the LCD bezel with screw holes aligned and then snap it into place by pressing down around the edges.



2. Replace and tighten screws **2** with a cross-head screwdriver to secure the deco strip to the LCD bezel.



Troubleshooting

Users may refer to the following tips or visit [MSI Monitor Support](#) for quick and easy troubleshooting when encountering common problems with the product. It is always suggested that users contact the authorized MSI service center for advanced tech support if needed.

The power LED is off.

- Press the monitor power button again.
- Check if the monitor power cable is properly connected.

No image.

- Check if the computer graphics card is properly installed.
- Check if the computer and monitor are connected to electrical outlets and are turned on.
- Check if the monitor signal cable is properly connected.
- The computer may be in Standby mode. Press any key to activate the monitor.

The screen image is not properly sized or centered.

- Refer to Preset Display Modes to set the computer to a setting suitable for the monitor to display.

No Plug & Play.

- Check if the monitor power cable is properly connected.
- Check if the monitor signal cable is properly connected.
- Check if the computer and graphics card are Plug & Play compatible.

The icons, font or screen are fuzzy, blurry or have color problems.

- Avoid using any video extension cables.
- Adjust brightness and contrast.
- Adjust RGB color or tune color temperature.
- Check if the monitor signal cable is properly connected.
- Check for bent pins on the signal cable connector.

The monitor starts flickering or shows waves.

- Change the refresh rate to match the capabilities of your monitor.
- Update your graphics card drivers.
- Keep the monitor away from electrical devices that may cause electromagnetic interference (EMI).

How to change your monitor resolution settings

https://www.msi.com/support/technical_details/MNT_Resolution

About monitor response time

https://www.msi.com/support/technical_details/MNT_Perf_Product_Responding_Speed

Powering Up After Maintenance

1. Connect the signal cable from the monitor to your PC. Connect the power cord to the monitor power jack and the electrical outlet. Turn on the monitor.
2. Depending on the monitor's signal ports, check the VGA, HDMI, DP ports in sequence. Changing the display to Red, Green, Blue, White and Black screens to check whether an image is abnormal.
3. Press the Menu key and adjust the Brightness or other functions to inspect the screen for abnormalities.
4. Check the Audio and volume control for abnormalities when connecting to various signal ports.
5. Reset the monitor after inspection. Turn off the monitor and disconnect all cables.

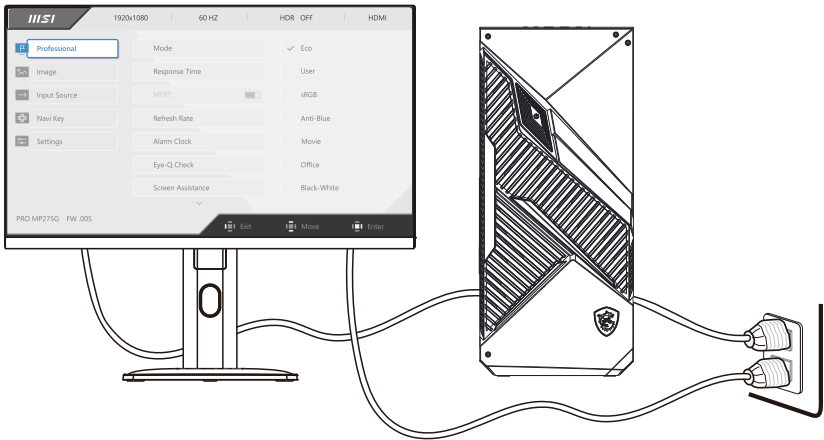

Recycling guidelines

Stand base

1. Follow [Stand Disassembly](#) to remove the adjustable stand from the monitor.
2. By disassembling quick release fasteners ① of the stand base to separate the adjustable stand and the base ②.

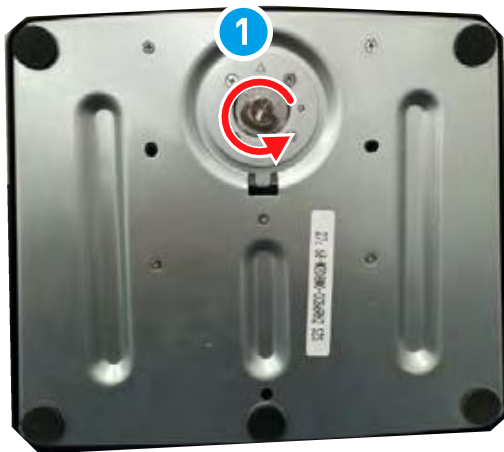

-
3. You'll see the stand and base separated.



- Reverse the base. Tear off rubber pads **3** and remove screws **4** under with a cross head screwdriver to open the base.



- Open and take out the steel base plate **5**, the plastic base plate can be recycled by qualified recyclers.

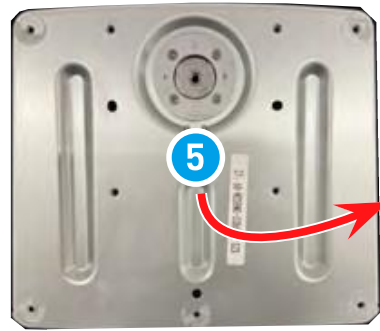

Both plates

- Unscrew the base **6** and remove all components **7**.

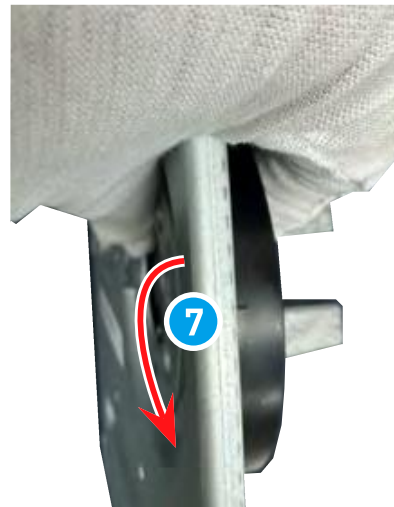
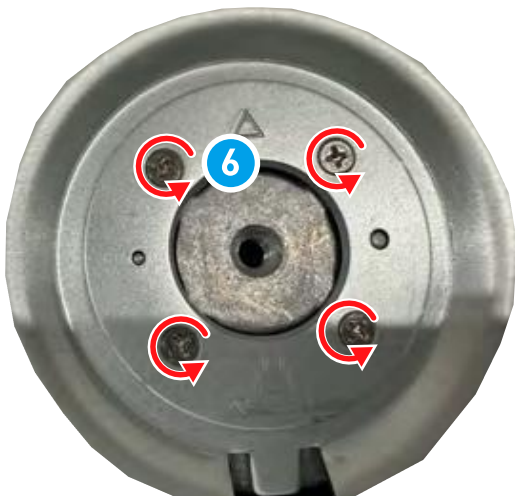

7. Both plates can be recycled by qualified recyclers.



VESA plate

8. Use a cross head screw driver to loose stand screws **8**.

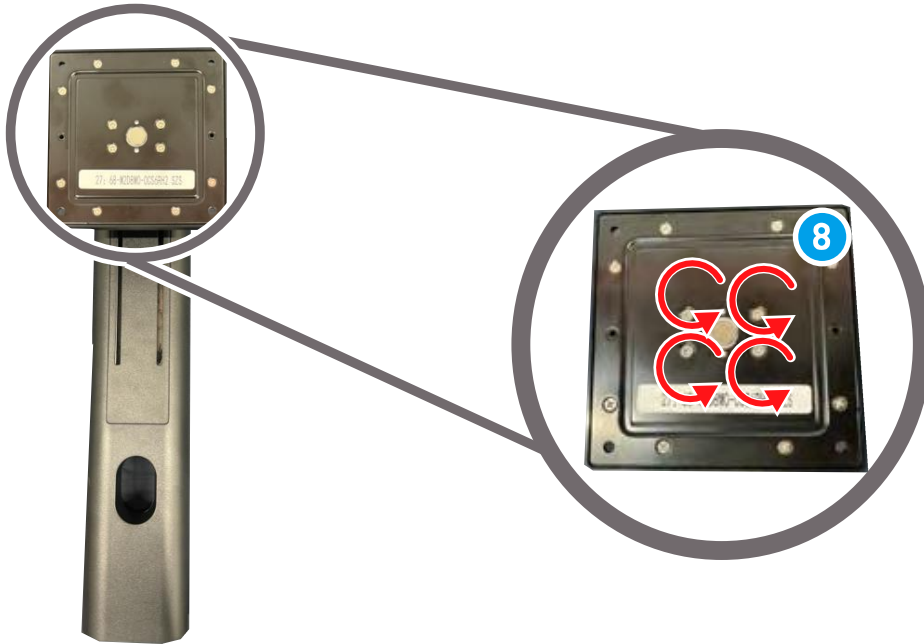

9. Use a pry tool to open up the steel and plastic VESA plate around the edge.



10. The plastic VESA plate can be recycled by qualified recyclers.

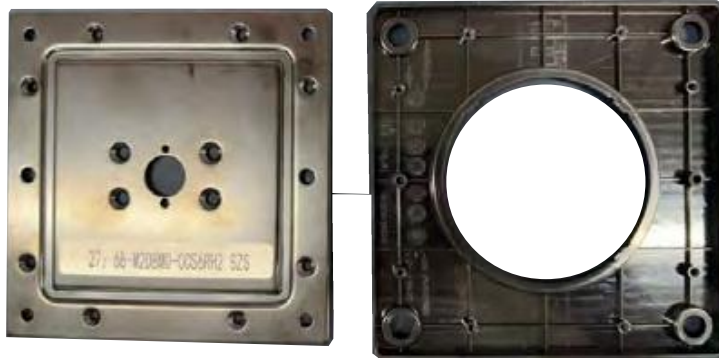

Stand enclosure

11. Take off the circular disc-shaped top 9 in the directions below 10 11 12.

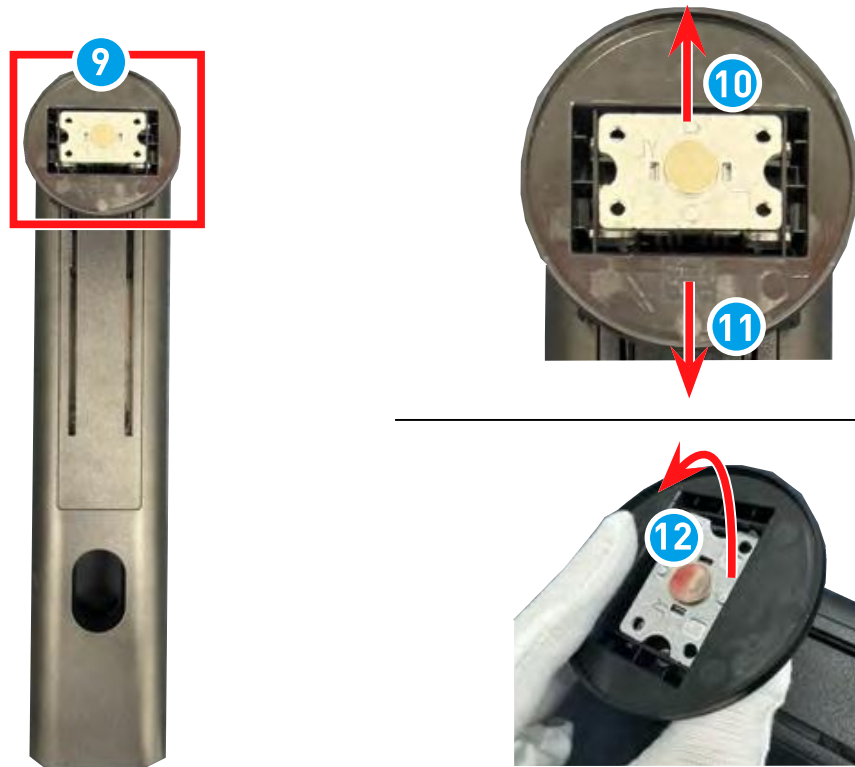

12. Remove screws 13 to take the cap off 14.

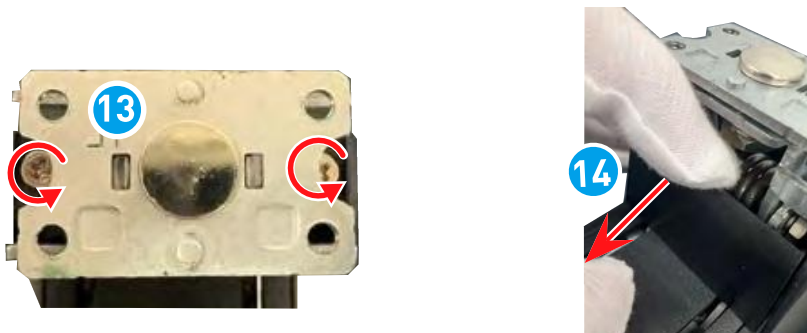

13. Straighten it with pliers **15** and remove the shell **16**.



14. Use a pry tool to carefully pry open the housing of the strut **17**.



15. Unscrew the screws **18** and the removed stand enclosure can be recycled by a qualified recycler.

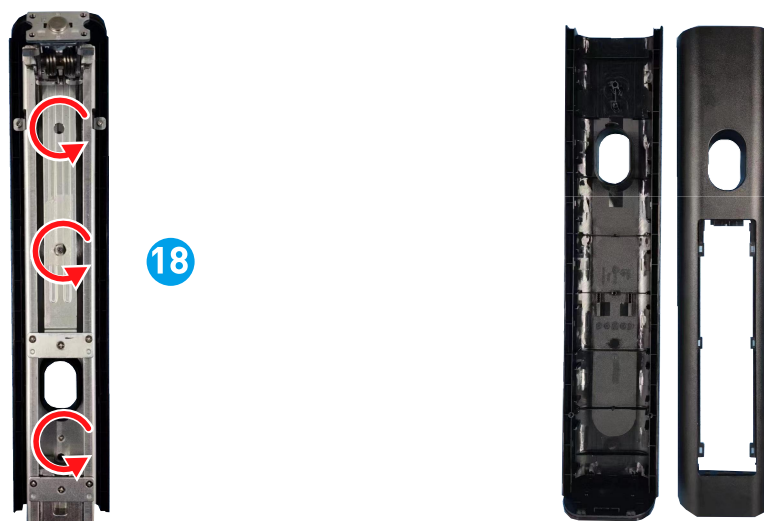

Rear Cover



Before recycling the separated plastic parts, please use a cross-head screwdriver or the diagonal pliers to remove all the screw bosses with copper sticks, if any.

1. Follow [Rear Cover Disassembly](#) to remove the rear cover.
2. Follow [Camera Disassembly](#) to remove the rear cover.
3. Follow [Navi Board & Navi Key Disassembly](#) to remove the rear cover.
4. Follow [Speakers Disassembly](#) to remove the rear cover.
5. After disassembling all components, the rear cover can be recycled by qualified recyclers.

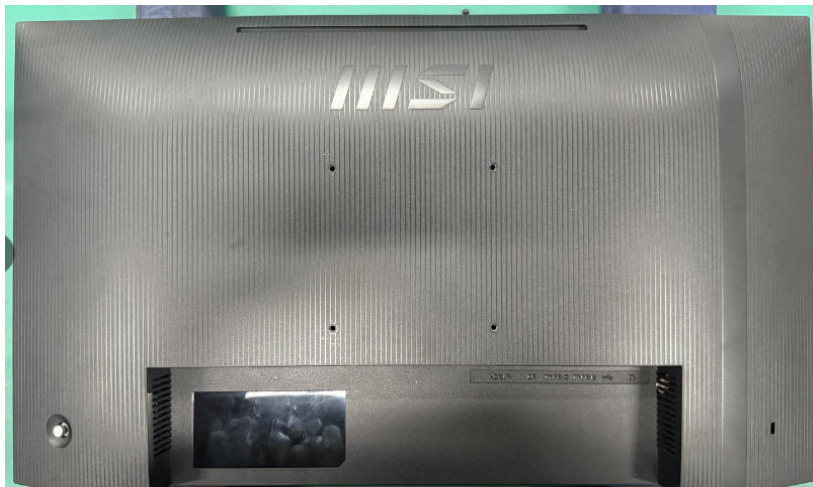

Removal of Deco Strip & LCD Bezel

1. Follow [LCD Panel & Shielding Cover Disassembly](#) to remove the deco strip & LCD bezel.
2. Place the display module in the workbench, remove the FFC cable **1**, and tear off the adhesive tapes **3**, and remove the conductive cloth **4**.

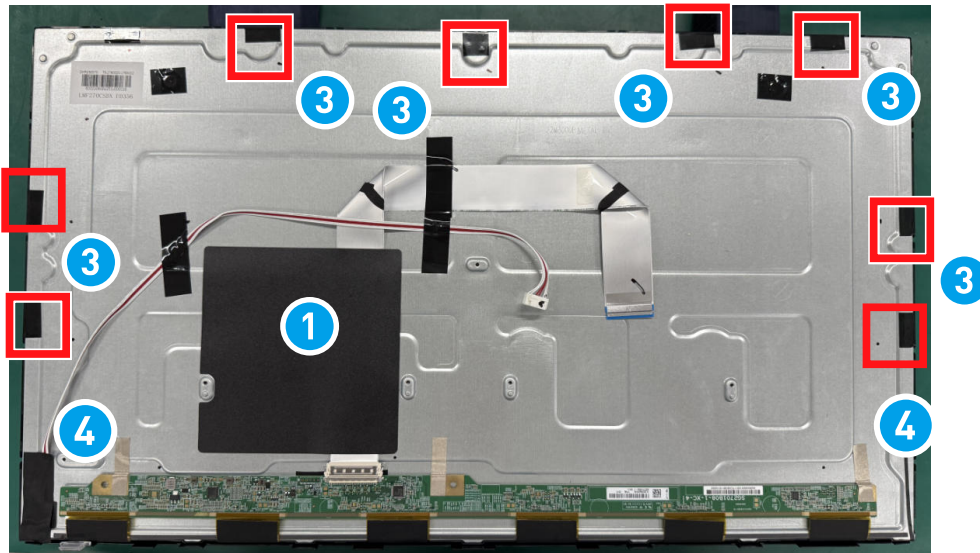

3. Place the monitor in face-down position. Remove deco strip & LCD bezel screws **5** that secure to the LCD panel with a cross-head screwdriver.



4. With the monitor face up, Gently pull outwards to remove the deco strip **6** from the LCD panel.

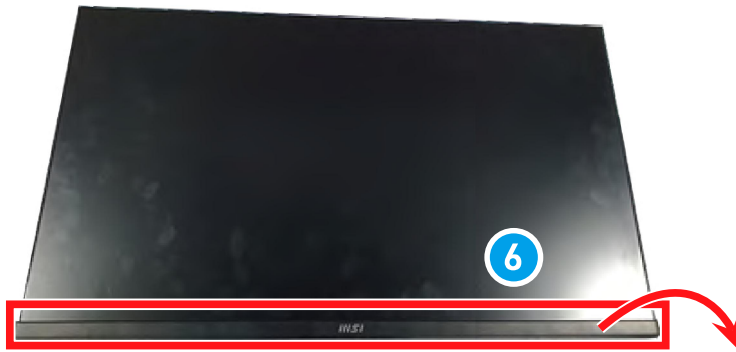

-
5. Take three wrinkle tape of adhesive paper and stick the source board to the LCD panel **7**

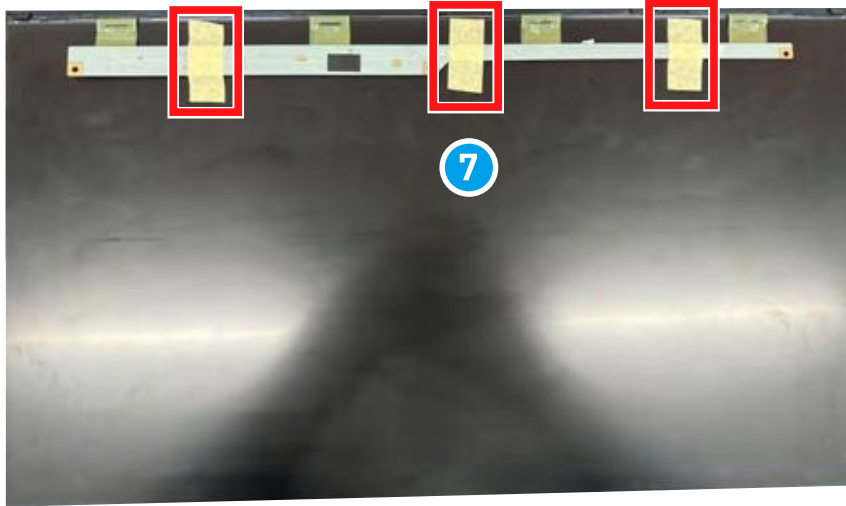

-
6. Use a pay bar to open the LCD bezel **8** and allow the rubber frame to separate from the back plate, which has a total of 26 buckles.

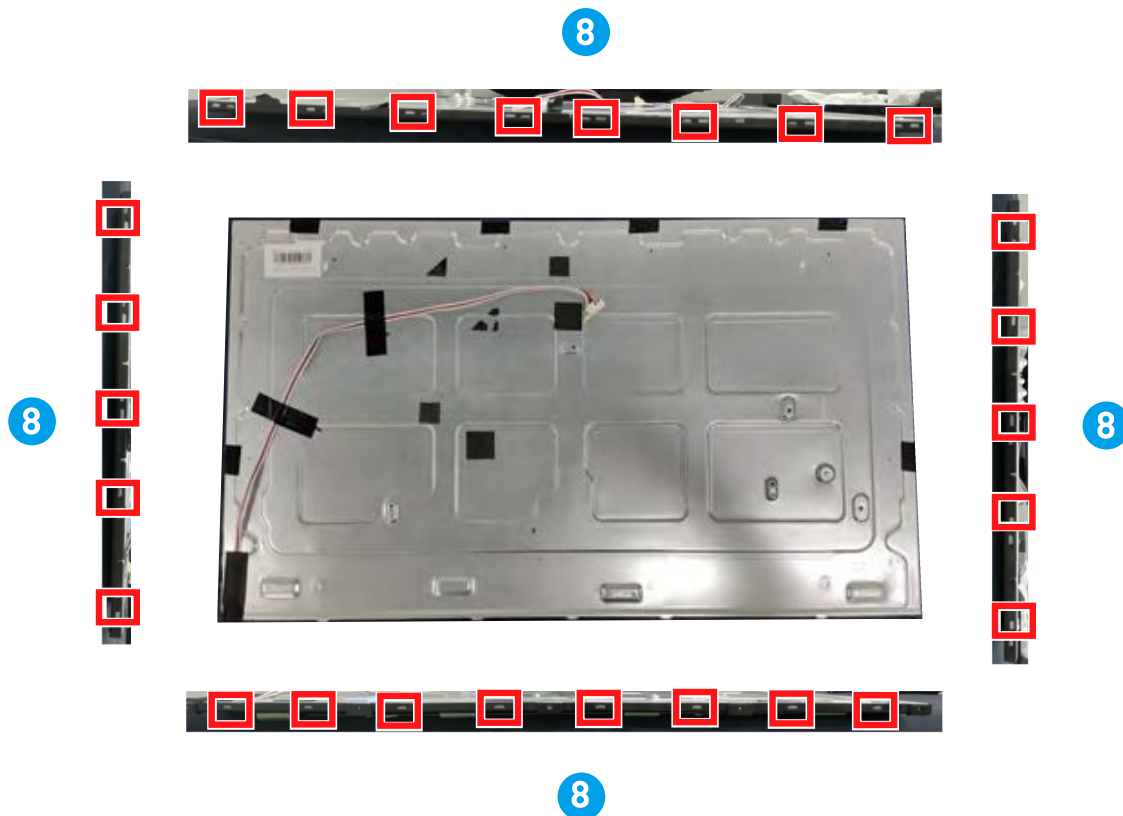



7. The LCD Bezel **9** can be recycled.

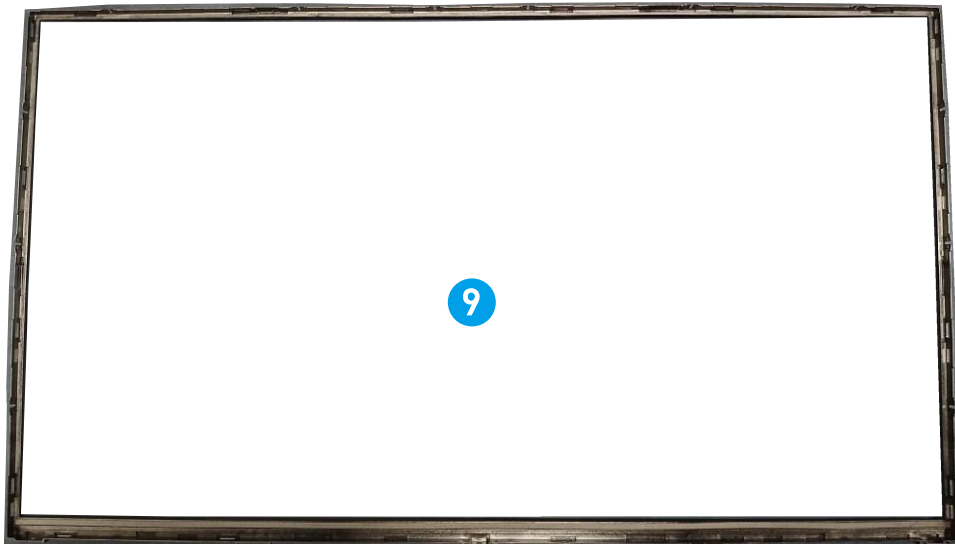

 **Important**

- 1.This disassembly must be done in a clean room.
- 2.You must wear an anti-static wrist strap when touching the motherboard and LCD panel.
3. An ion fan must be available to remove static electricity.
- 4.Please take this process gently to avoid LCD panel damage.

Product End-of-Life Instructions



Important

MSI Environmental Information

Information on MSI's Environmental initiatives, policies, programs and goals can be found at [Environmental Sustainability Policy](#).

Purpose

This information is to provide the guidance to recyclers on the presence of materials and components at the product level, as required by the EU WEEE and amending Directive.

Information on Component and Material Identification

The following substances, preparations, or components should be disposed of or recovered separately from other WEEE in compliance with Article 4 of EU Council Directive 75/442/EEC.

Identify materials for materials and components of the waste electrical and electronic equipment list.

*1: The following item numbers correspond with those in [Product Components and Accessories](#).

Materials	Item*1	Location
Polychlorinated biphenyl (PCB) containing capacitors and all polychlorinated biphenyls and polychlorinated terphenyls (PCB/PCT) containing electrical equipment	—	Absent
Mercury containing components, such as switches or backlighting lamps	—	Absent
Batteries	—	Absent
Printed circuit boards of mobile phones generally, and of other devices if the surface of the printed circuit board is greater than 10 square centimeters	5	Mainboard
	8	Navi Board
	4	Power Board
	12	Camera PCB
	7	HUB PCB
	2	Source Board
Toner cartridges, liquid and paste, as well as color toner	—	Absent
Plastic containing abominated flame retardants	—	Absent

Materials	Item*1	Location
Asbestos waste and components which contain asbestos	—	Absent
Cathode ray tubes	—	Absent
Chlorofluorocarbons (CFC), Hydrochlorofluorocarbons (HCFC) or Hydrofluorocarbons (HFC), Hydrocarbons (HC)	—	Absent
Gas discharge lamps	—	Absent
Liquid crystal displays (together with their casing where appropriate) of a surface greater than 100 square centimeters and all those back-lighted with gas discharge lamps	2	LCD Panel
External electric cables	16	Power Cord
Components containing refractory ceramic fibers	—	Absent
Components containing radioactive substances, or materials that become radioactive	—	Absent
Electrolytic capacitors containing substances of concern (height > 25 mm, diameter > 25 mm or proportionately similar volume)	4	Power Board
Beryllium and its compounds (including Beryllium Oxide)	—	Absent
Liquids	—	Absent

Product Take-Back Service

Waste electrical equipment may contain hazardous substances and thus endanger human health & the environment. Proper disposal is therefore required. MSI provides free recycling of EPEAT-registered products to ensure that the product reaches the end of its useful life and that it is recycled responsibly.

To properly recycle your equipment through this service, please follow the steps:

1. Please delete your personal data from your waste equipment.
2. [CLICK HERE](#) to learn how to recycle your end-of-life product.
3. Find the MSI recycling location nearby on the website.
4. Contact the designated recycling location by phone or email to schedule your pickup. The customers are responsible for any shipping and delivery charges.

OSD Setup

OSD Setup

This chapter provides you with essential information on OSD Setup.



All information is subject to change without prior notice.

Navi Key

The monitor comes with a Navi Key, a multi-directional control that helps navigate the On-Screen Display (OSD) menu.

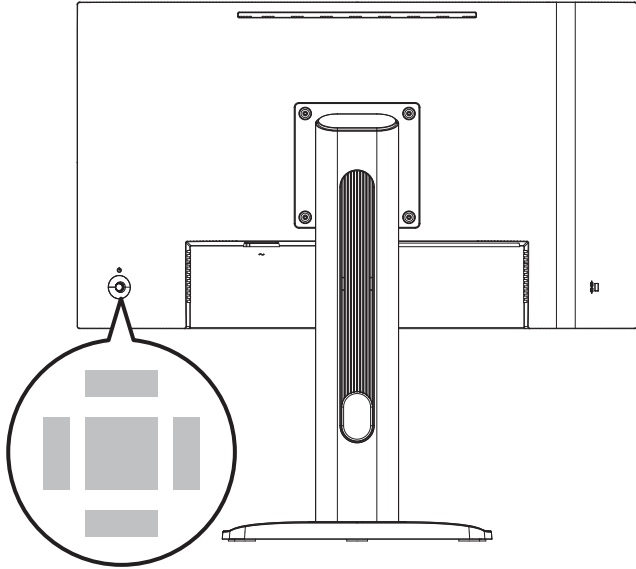

Up/ Down/ Left/ Right:

- selecting function menus and items
- adjusting function values
- entering into/exiting from function menus

Press (OK):

- launching the On-Screen Display (OSD)
- entering submenus
- confirming a selection or setting

Hot Key

- Users may enter into preset function menus by moving the Navi Key up, down, left or right when the OSD menu is inactive.
- Users may customize their own Hot Keys to enter into different function menus.

OSD Menus

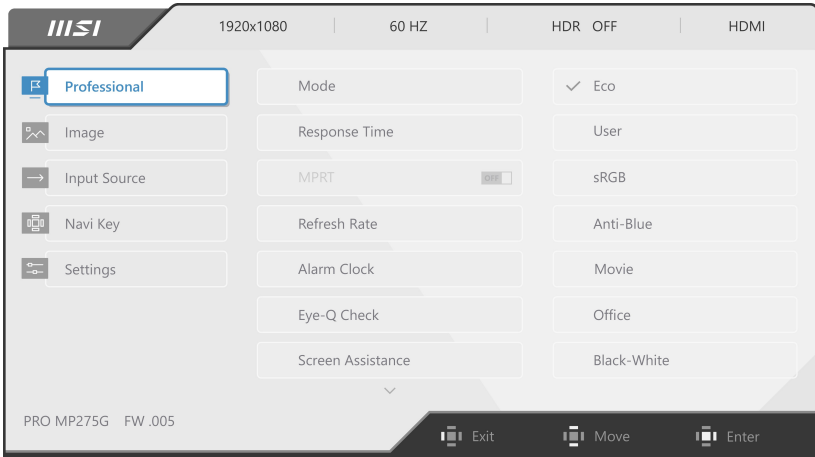

Image

1st Level Menu	2nd/3rd Level Menu	Description						
Brightness	0-100	<ul style="list-style-type: none"> Properly adjust Brightness according to the surrounding lighting. 						
Contrast	0-100	<ul style="list-style-type: none"> Properly adjust Contrast to relax your eyes. 						
Sharpness	0-5	<ul style="list-style-type: none"> Sharpness improves clarity and details of images. 						
Image Enhancement	OFF	<ul style="list-style-type: none"> Image Enhancement enhances image edges to improve their acutance. 						
	Weak							
	Medium							
	Strong							
	Strongest							
Low Blue Light	OFF	<ul style="list-style-type: none"> Low Blue Light protects your eyes against blue light. When enabled, Low Blue Light adjusts the screen color temperature to a more yellow glow. When Mode is set to Anti-Blue, it is mandatory to enable Low Blue Light. 						
	ON							
HDCR	OFF	<ul style="list-style-type: none"> HDCR enhances image quality by increasing the contrast of images. Activating HDCR will affect: <table border="1" data-bbox="604 1385 934 1471"> <thead> <tr> <th>Affected Function</th> <th>Function Status</th> </tr> </thead> <tbody> <tr> <td>» Brightness</td> <td>Unable to select</td> </tr> <tr> <td>» MPRT</td> <td>Set to OFF</td> </tr> </tbody> </table> 	Affected Function	Function Status	» Brightness	Unable to select	» MPRT	Set to OFF
	Affected Function		Function Status					
» Brightness	Unable to select							
» MPRT	Set to OFF							
	ON							

1st Level Menu	2nd/3rd Level Menu	Description
Color Temperature	Cool	<ul style="list-style-type: none"> Use Up or Down Button to select and preview mode effects. Press the Middle Button to confirm and apply your mode type. Users can adjust Color Temperature in Customization mode.
	Normal	
	Warm	
	Customization	
	R (0-100)	
	G (0-100)	
	B (0-100)	
Auto Config		<ul style="list-style-type: none"> For D-Sub only, this setting will be grayed out when detecting other input sources.
Clock	0-100	<ul style="list-style-type: none"> Adjust Clock setting. For D-Sub only, this setting will be grayed out when detecting other input sources.
Phase	0-100	<ul style="list-style-type: none"> Adjust Phase setting. For D-Sub only, this setting will be grayed out when detecting other input sources.
H.Position	0-100	<ul style="list-style-type: none"> Adjust H.Position setting. For D-Sub only, this setting will be grayed out when detecting other input sources.
V.Position	0-100	<ul style="list-style-type: none"> Adjust V.Position setting. For D-Sub only, this setting will be grayed out when detecting other input sources.

Input Source

1st Level Menu	2nd Level Menu	Description
HDMI™		<ul style="list-style-type: none"> Users can adjust Input Source in any mode.
DP		
D-Sub		
Auto Scan	OFF	<ul style="list-style-type: none"> Users can use the Navi Key to select Input Source at below status: <ul style="list-style-type: none"> While "Auto Scan" is set to "OFF" with the monitor at power saving mode; While "No Signal" message box is shown on the monitor.
	ON	

Navi Key

1st Level Menu	2nd Level Menu	Description
Up Down Left Right	OFF	<ul style="list-style-type: none"> All Navi Key items can be adjusted via OSD Menus.
	Brightness	
	Mode	
	Alarm Clock	
	Input Source	
	Refresh Rate	
	Info. On Screen	
	Audio Volume	

Settings

1st Level Menu	2nd Level Menu	Description
Language	繁體中文	<ul style="list-style-type: none"> Users have to press the Middle Button to confirm and apply the Language setting. Language is an independent setting. Users' own language setting will override the factory. When users set Reset to Yes, Language will not be changed.
	English	
	Français	
	Deutsch	
	Italiano	
	Español	
	한국어	
	日本語	
	Русский	
	Português	
	简体中文	
	Bahasa Indonesia	
	Türkçe	
(More languages coming soon)		
Transparency	0-5	<ul style="list-style-type: none"> Users can adjust Transparency in any mode.
OSD Time Out	5-30s	<ul style="list-style-type: none"> Users can adjust OSD Time Out in any mode.
Power Button	OFF	<ul style="list-style-type: none"> When set to OFF, users can press the power button to turn off the monitor.
	Standby	<ul style="list-style-type: none"> When set to Standby, users can press the power button to turn off the panel and backlight.

1st Level Menu	2nd Level Menu	Description				
Info. On Screen	OFF	<ul style="list-style-type: none"> The information of the monitor status will be shown on the right side of the screen. Activating Info. On Screen will affect: <table border="1" data-bbox="537 252 867 311"> <thead> <tr> <th>Affected Function</th> <th>Function Status</th> </tr> </thead> <tbody> <tr> <td>» Eye-Q Check</td> <td>Set to OFF</td> </tr> </tbody> </table> 	Affected Function	Function Status	» Eye-Q Check	Set to OFF
	Affected Function		Function Status			
» Eye-Q Check	Set to OFF					
ON						
Audio Volume	0-100	<ul style="list-style-type: none"> Users can adjust Audio Volume in any mode. 				
Reset	YES	<ul style="list-style-type: none"> Users can Reset and restore settings to original OSD Default in any mode. 				
	NO					