



PRO Series

LCD Monitor

PRO MP341CQPHGN E12 (3PFA)

Service Guide

Contents

Copyright and Trademarks Notice.....	4
Revision.....	4
How to Use this Service Guide	4
Safety Instructions.....	5
Power	5
Environment	5
Conditional Warranty Service	6
Upgrade and Service	6
Publicly Available Service Information	7
Disassembly & Assembly	9
Product Components and Accessories	10
Product Upgradeability and Repairability	12
Recommended Tools	13
Screw List.....	13
Preparation for Disassembly	14
Stand	16
Stand Disassembly	16
Stand Assembly	17
Rear Cover	18
Rear Cover Disassembly	18
Rear Cover Assembly	20
Speakers	22
Speakers Disassembly.....	22
Speakers Assembly.....	23
LCD Panel & Shielding Cover	24
LCD Panel & Shielding Cover Disassembly.....	24
LCD Panel & Shielding Cover Assembly.....	26

Mainboard	28
Mainboard Disassembly	28
Mainboard Assembly	29
Power Board (Internal Power Supply)	30
Power Board (Internal Power Supply) Disassembly	30
Power Board (Internal Power Supply) Assembly	31
Navi Board & Navi Key	32
Navi Board & Navi Key Disassembly	32
Navi Board & Navi Key Assembly	33
LED Board	34
LED Board Disassembly	34
LED Board Assembly	35
Powering Up After Maintenance	36
Troubleshooting	37
Recycling Guidelines	38
Stand	38
Rear Cover	43
Removal of LCD bezel	44
Product End-of-Life Instructions	48
Purpose	48
Information on Component and Material Identification	48
Product Take-Back Service	49
OSD Setup	51
OSD Setup	52
Navi Key	52
OSD Menus	54
Image	54
Input Source	55
PIP/PBP	56
Navi Key	57
Settings	57

Copyright and Trademarks Notice

Copyright © 2026 Micro-Star Int'l Co., Ltd. All rights reserved.

The MSI logo used is a registered trademark of Micro-Star Int'l Co., Ltd. Third-party trademarks and names are the properties of their respective owners. No warranty as to accuracy or completeness is expressed or implied. MSI reserves the right to make changes to this document without prior notice.

Revision

V1.0, 2026/03

How to Use this Service Guide

This Service Guide provides in-depth illustration of disassembling/assembling the product. Since the topics in this guide may be related, it is recommended that you read it from cover to cover first. After that, you may go directly to any specific topic that most meets your immediate needs.

Safety Instructions

Adhere to safety precautions when handling the product to prevent harm or damage to individuals or the product's functionality.

Power

- If the power cord comes with a 3-pin plug, do not disable the protective earth pin from the plug. The monitor must be connected to an earthed mains socket-outlet.
- Disconnect all power sources and place the product on a steady surface before disassembly/assembly.
- When unplugging the power cord, always hold the connector part of the cord. Never pull the cord directly.
- Place the power cord in a way that people are unlikely to step on it. Do not place anything on top of the power cord.
- If this product comes with an adapter, use only the MSI provided AC adapter approved for use with this product.

Environment

- Do not place the product in environments subject to mist, smoke, vibration, excessive dust, salty or greasy air, or other corrosive gases and fumes.
- To avoid electrostatic discharge, use an anti-static wrist strap before handling components. Always handle electrostatic-sensitive components, parts, and assemblies only at static-free work areas.
- Handle components with care. Do not touch the pins or contacts on a component.
- Place components on a grounded anti-static pad or on the bed that came with the components whenever the components are separated from the product.
- Handle the display panel with extra care as it is fragile and could break.
- Do not perform any maintenance with wet hands.
- Prevent foreign substances, such as water, other liquids or chemicals, from entering the product while performing disassembly/assembly.
- After assembly, ensure that all screws are replaced and no stray screws remain inside the product.

Conditional Warranty Service

MSI provides a conditional warranty service for selected models. Please visit [MSI Member Center](#) or futher information.

Upgrade and Service

Available hardware features may only be offered as part of an upgrade, repair, or replacement service offered by MSI or an authorized service provider.

MSI offers customers replacement parts, product repair and services for 3 years from the date of sale for all EPEAT-registered products.

Damages caused by servicing of products not authorized by MSI or the use of modified or non-MSI authorized parts or components are not covered by MSI Limited Warranty Agreement.

Visit [MSI Service Location](#) to obtain these services offered by MSI.

Go to [MSI Web Ticket](#) to receive further assistance if needed.

Publicly Available Service Information

Service Information	Section
Disassembly instructions including identifying the required tools.	<u>Product Components and Accessories</u> <u>Recommended Tools</u>
Exploded diagram of parts.	<u>Product Components and Accessories</u>
List of spare parts including manufacturer-approved spare parts and how to obtain them.	<u>Product Upgradeability and Repairability</u>
Maintenance procedures or guidance on where to obtain the procedures.	<u>Monitor Support</u> <u>OSD Setup</u>
Troubleshooting instructions, software diagnostic tools, troubleshooting videos or other troubleshooting guidance.	<u>Troubleshooting</u>
Instructions on how to obtain software updates (not applicable to display products).	N/A
Instructions on how the user can remove personal data. If the instructions require destruction of the storage, instructions to replace the storage shall be provided (not applicable to display products).	N/A

It is acceptable for service instructions to exclude information that, as determined by the manufacturer:

a) May expose the user to risk of injury, or	N/A
b) Breaches intellectual property rights, or	N/A
c) Compromises user privacy or security, or	N/A
d) Involves the disassembly of a battery pack or power supply	N/A
If claiming any of the four exclusions above the manufacturer shall demonstrate how the product is restored to normal operating condition after being repaired. Repair may include replacement of the component(s) associated with the exclusion.	N/A

Disassembly & Assembly

Product Components and Accessories

 **Important**

MSI provides the below list of components for the system configuration purchased and within 2 years after discontinuation of the product to increase the operational life of that product. Further services can be obtained by contacting [MSI Online Customer Service](#).

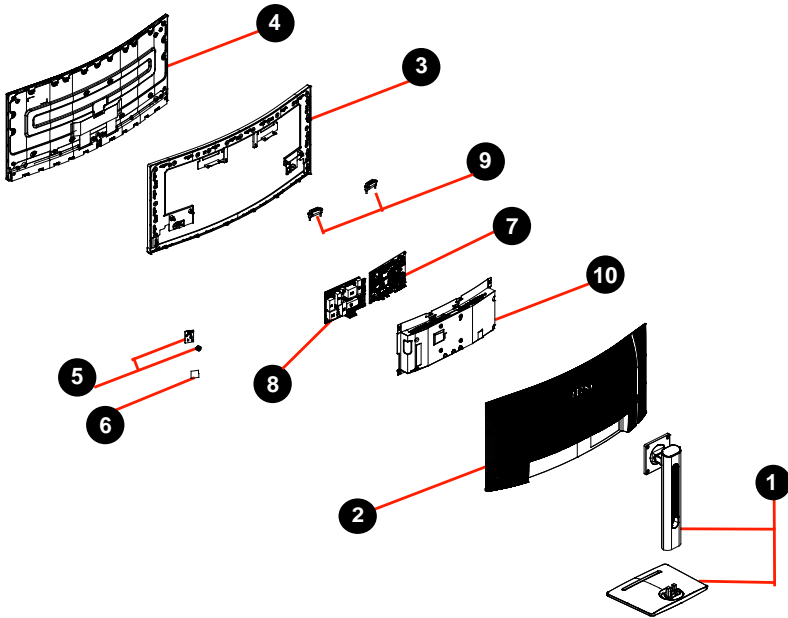

1. Stand
2. Rear Cover
3. Middle frame
4. LCD Panel
5. Navi Board & Navi Key
6. LED Board
7. Mainboard
8. Power Board (Internal Power Supply)
9. Speakers
10. Shielding Cover

Product Upgradeability and Repairability

Hardware features for upgradeable, repairable or replaceable using only commonly available tools and listing of replaceable spare parts by products can be obtained by contacting [MSI Online Customer Service](#).

For replacement, repair, or upgrade methods, please refer to the [hyperlinks](#) in the table below.

Hardware feature items	Upgradeable	Repairable	Replaceable	Soldering
The main processor(s) or system on a chip (SOC)	No	No	No	Yes
The main memory capacity of the system	No	N/A	N/A	N/A
Mass storage capacity of the system	N/A	N/A	N/A	N/A
Wireless networking capability	N/A	N/A	N/A	N/A
Graphics capability (integrated or discrete)	N/A	N/A	N/A	N/A
Display panel or display assembly	N/A	No	Yes	No
Integrated mechanical keyboards	N/A	N/A	N/A	N/A
All batteries	N/A	N/A	N/A	N/A
All external and internal power supplies	N/A	No	Yes	No
All fan assemblies	N/A	N/A	N/A	N/A
AND At least two of the following (or one, if all remaining are absent from product):	Upgradeable	Repairable	Replaceable	Soldering
Speakers	No	No	Yes	No
Camera	N/A	N/A	N/A	No
Touchpad	N/A	N/A	N/A	N/A
I/O connectors and external power connection	No	No	No	Yes
Readers (eg. magnetic stripe, Dallas key, fingerprint, Smart card)	N/A	N/A	N/A	No

Recommended Tools

The following tools may be needed while performing the disassembly and assembly procedures.

- Cross-head screwdriver
- Parallel screwdriver (optional)
- Tweezers
- Pry tool
- Diagonal pliers (optional)
- Heat gun (optional)
- Anti-static gloves
- Anti-static wrist strap (optional)
- Anti-static mat with grounding wire (optional)

Screw List

Please refer to the screw list below while proceeding the disassembly and assembly of the computer.

Note: This screw list is for reference only and may vary from models to models. It is highly recommended that users contact the authorized service center for further assistance.

Component	Screw Type	Quantity
Stand	M4*10	4
LCD Panel	M3*3.8	13
Shielding Cover	D3*6	4
Mainboard	D3*6	4
DP&HDMI Connector	D3*6	2
Power Board	D3*6	4
	M4*6	1
Navi Board	Q3*6	3

Preparation for Disassembly

1. Power off the monitor and your computer.
2. Disconnect the power cords of your monitor and PC from the electrical outlet.
3. Disconnect the all cables power cord from the monitor.

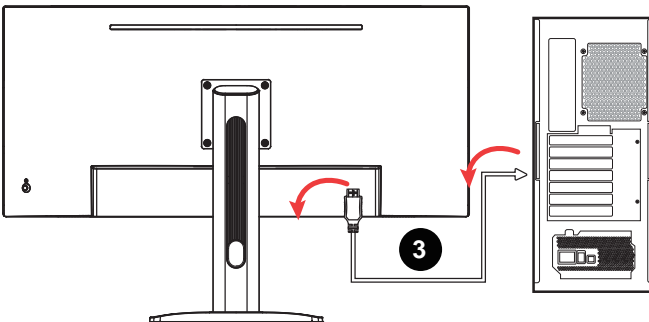
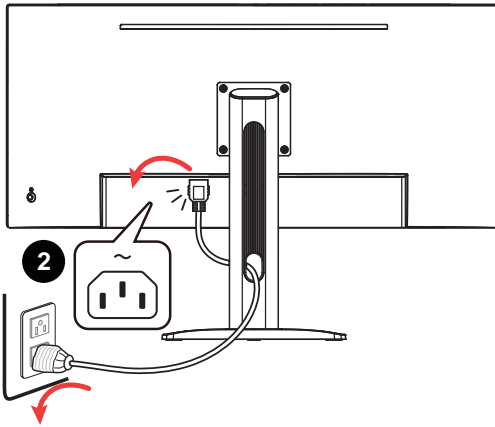
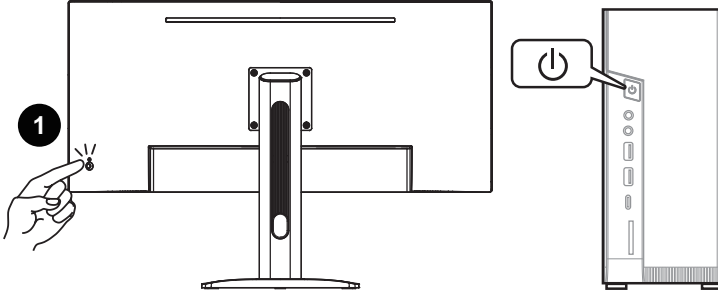



Important

- *Disconnect all power sources and place the monitor on a steady surface before disassembly/assembly.*
- *When unplugging the power cord, always hold the connector part of the cord. Never pull the cord directly.*
- *Do not place the monitor in environments subject to mist, smoke, vibration, excessive dust, salty or greasy air, or other corrosive gases and fumes.*
- *To avoid electrostatic discharge, use an anti-static wrist strap before handling electrostatic-sensitive components.*
- *Handle the display panel with extra care as it is fragile and could break.*
- *Do not perform any maintenance with wet hands.*
- *After assembly, ensure that all screws are replaced and no stray screws remain inside the monitor.*

Stand

Stand Disassembly

1. Place the monitor face down on a clean, curved foam pad.
2. Locate and remove the screws that secure the stand with a cross-head screwdriver ①.
3. Lift up and remove the stand ② from the monitor



Stand Assembly

1. Place the monitor face down on a clean, curved foam pad.
2. Align the screw holes on the stand with the screw holes on the rear cover.
3. Replace and fasten the screws with a cross-head screwdriver ① to secure the stand ②.



Rear Cover

Rear Cover Disassembly

1. Using a plastic scribe, pry open the rear cover starting from the bottom edge of the monitor **1**. And then pry open the right side **2**, left side **3** and top side **4** of the rear cover.

 **Important**

- Avoid finger pressure on the screen surface, it may damage the display.



2. Gently lift the rear cover up **5** and be careful when disconnecting the Navi board cable **6**.

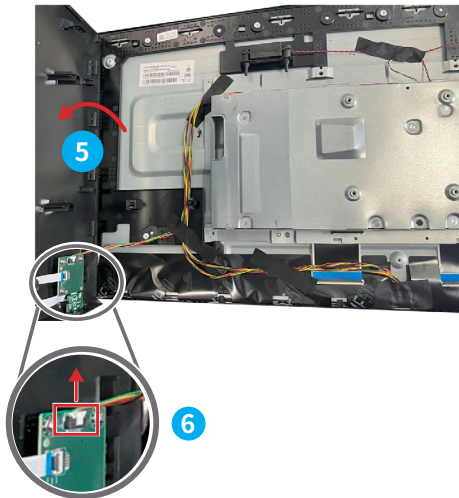

3. Open the latch, and disconnect the LED board cable (7). Remove Navi board screws (8) with a cross-head screwdriver. Gently deroute and remove the Navi board (9) from the rear cover.

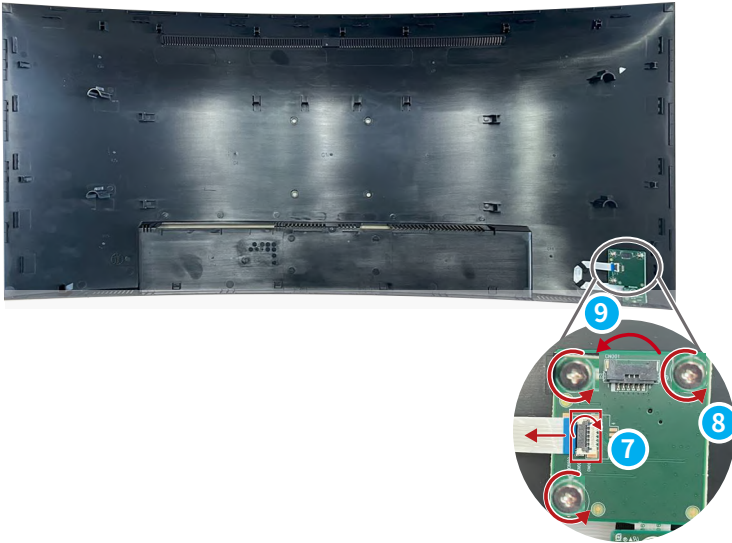

4. Remove LED board from the rear cover to finish (10).



Rear Cover Assembly

1. Insert LED board to start assembling the rear cover ①.

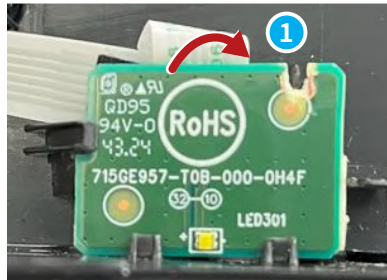

2. Insert Navi board to the rear cover ②, secure screws with a cross-head screwdriver ③. Connect the LED board cable, and close the latch ④.

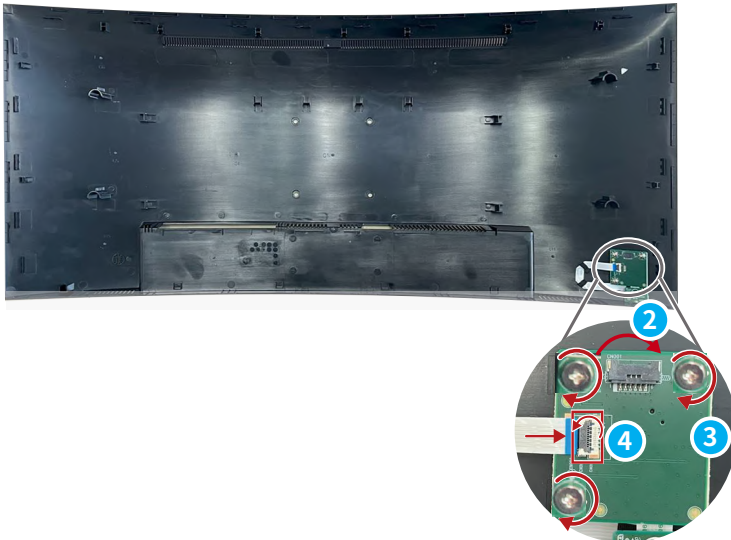

3. Connect the Navi board cable to the mainboard carefully **5**, then close the rear cover **6**.

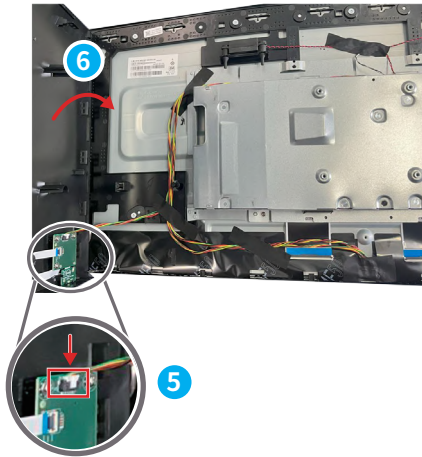

4. Align the tabs on the rear cover with the slots **7**. Gently push the rear cover downwards **8** to finish.



Speakers

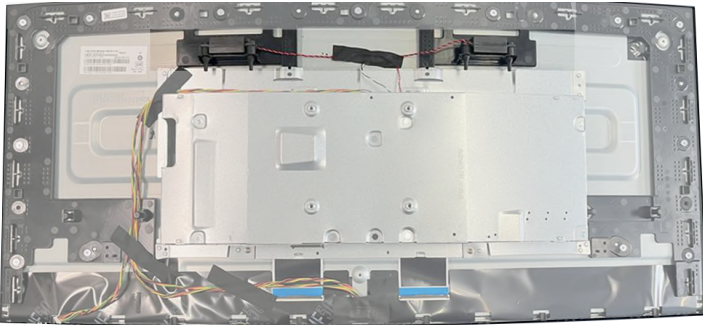

Speakers Disassembly

1. Peel the tape **1** that secure the speaker cables to the display panel.

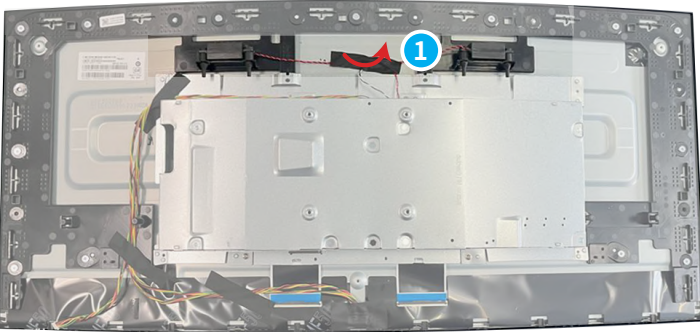

2. Disconnect the speaker cables **2** and remove the speakers **3** from the middle frame to finish.

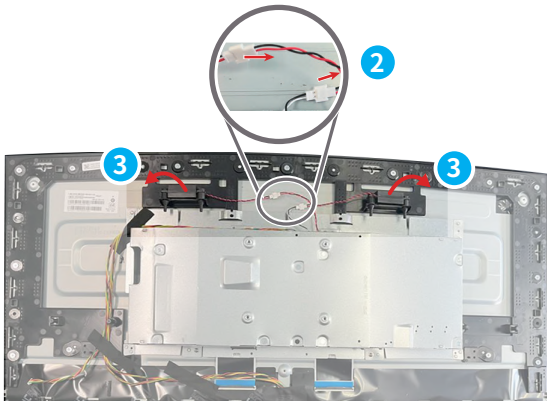

Speakers Assembly

1. Align speakers to the middle frame **1**. Connect the speaker cables **2**.

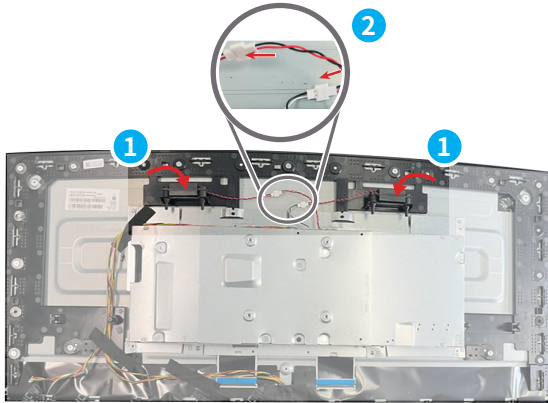

2. Adhere the tape **3** to secure the speaker cables to the display panel to finish .

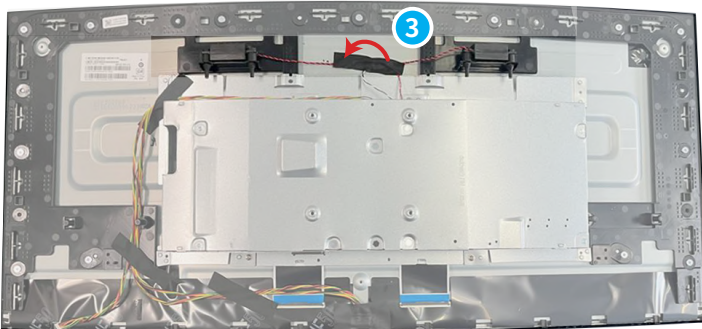

LCD Panel & Shielding Cover

LCD Panel & Shielding Cover Disassembly

1. Peel the tapes **1** that secure the lightbar cables and Navi board cable to the panel. Disconnect the lightbar cables **2** from the connectors on the display panel.

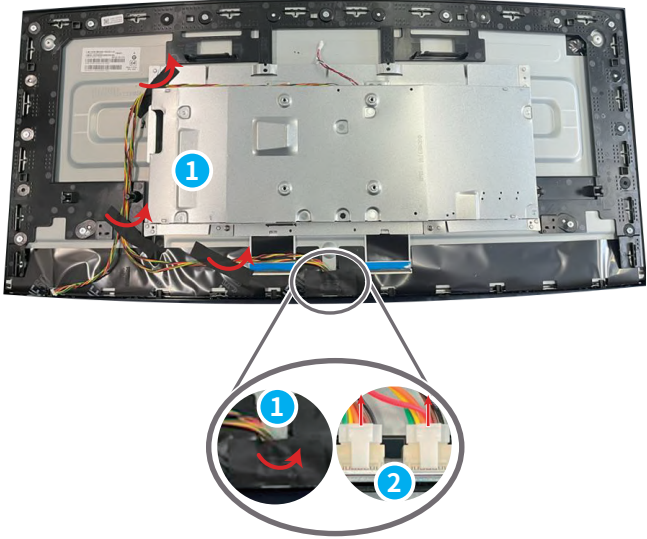

2. Remove the screws **3** with a cross-head screwdriver to remove shielding cover.

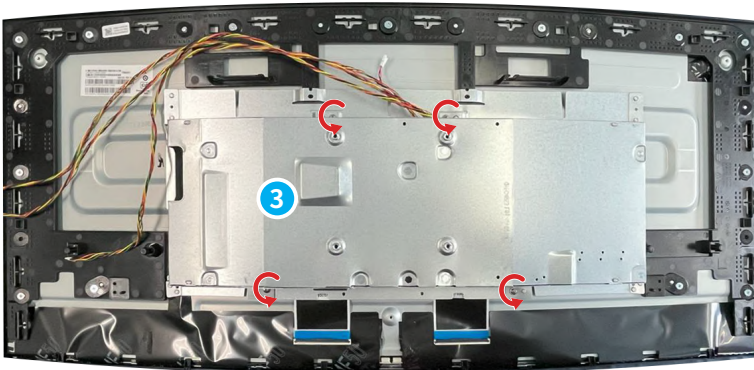

3. Disconnect the panel signal cable **4** to remove the shielding cover .

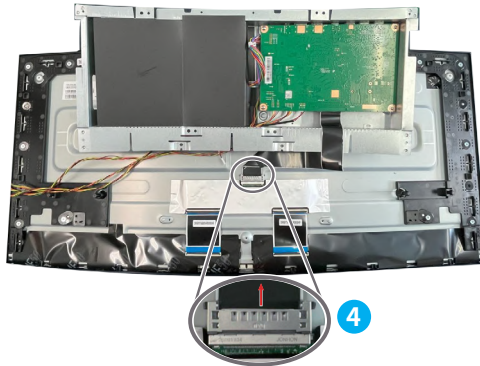

4. Remove the middle frame screws **5** with a cross-head screwdriver. Separate the LCD panel and middle frame **6**.



5. The LCD panel and the middle frame.

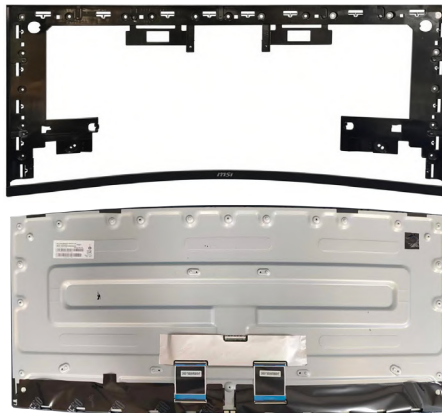

LCD Panel & Shielding Cover Assembly

1. Align the LCD panel and middle frame ①.



2. Secure the middle frame screws ② with a cross-head screwdriver .

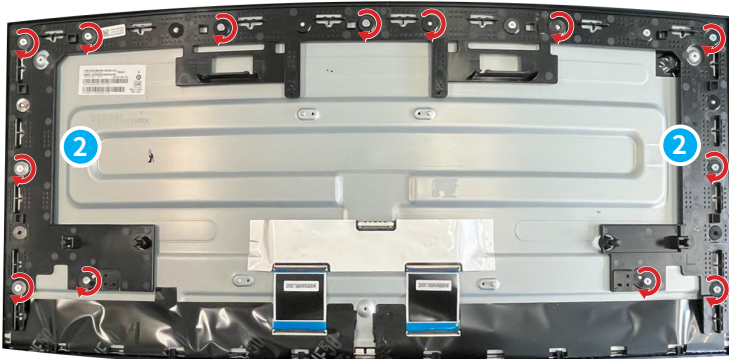

3. Put on the shielding cover and connect the panel signal cable ③.

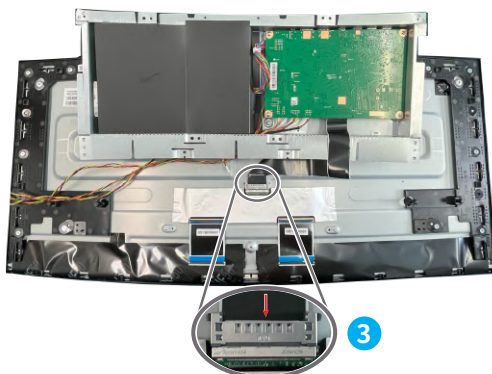

- Secure the screws **4** with a cross-head screwdriver.

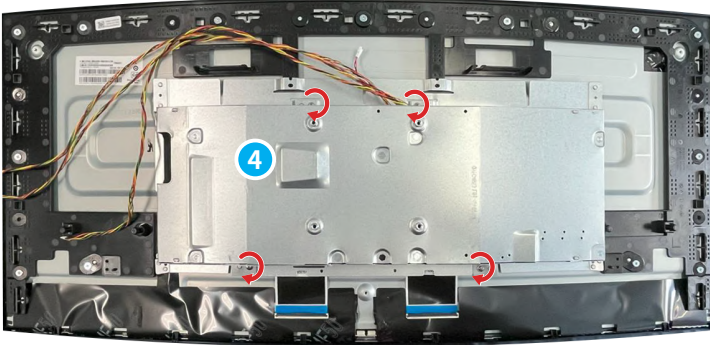

- Connect the lightbar cables **5**. Adhere the tapes **6** that secure the lightbar cables and navi board cable to the display panel to complete.

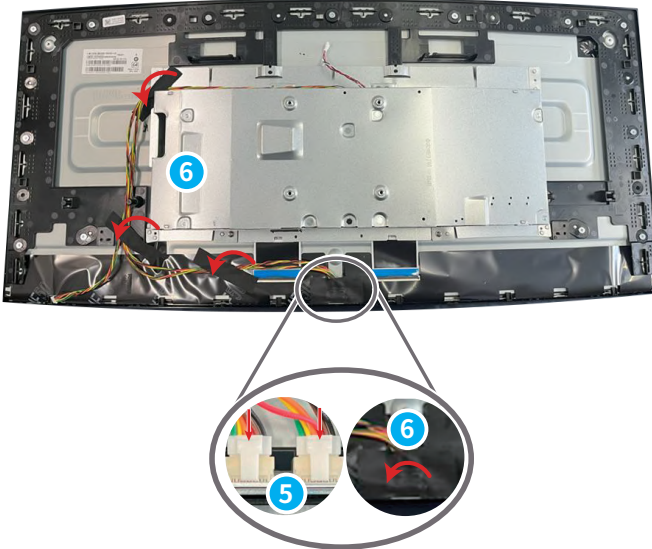

Mainboard



Mainboard Disassembly

1. Locate the main board, remove screws **1** **2** with a cross-head screw driver, flip it over **3** and disconnect the cables **4** **5** to finish.

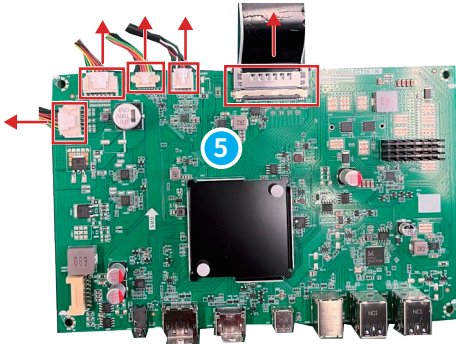
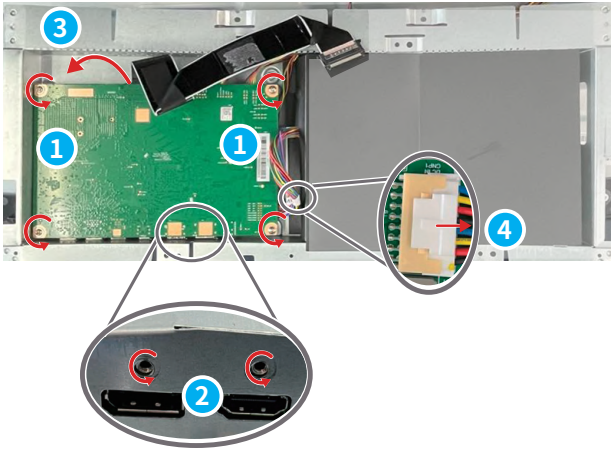

Mainboard Assembly

1. Connect the cables **1** **2** to mainboard . Flip the mainboard over **3**. Secure the screws **4** **5** with a cross-head screwdriver to finish.

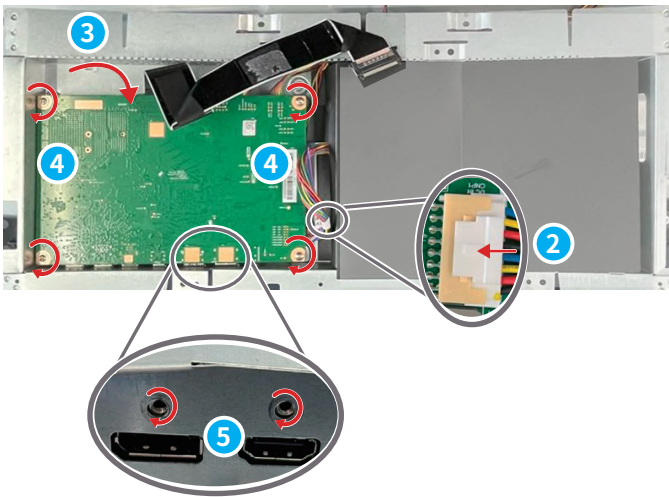
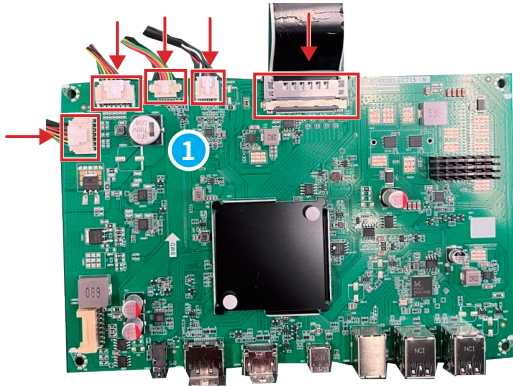

Power Board (Internal Power Supply)

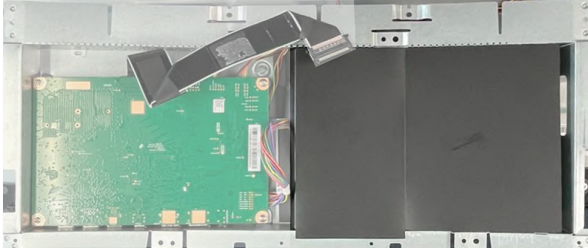

Power Board (Internal Power Supply) Disassembly

1. Locate the power board, remove the mylar ①. Remove screws ② with a cross-head screwdriver, flip it over ③ and disconnect the cables ④ ⑤ to finish.

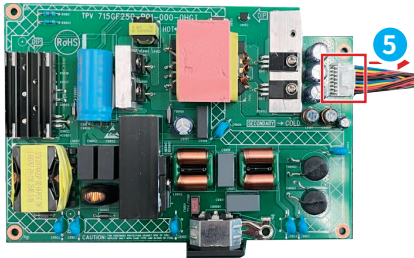
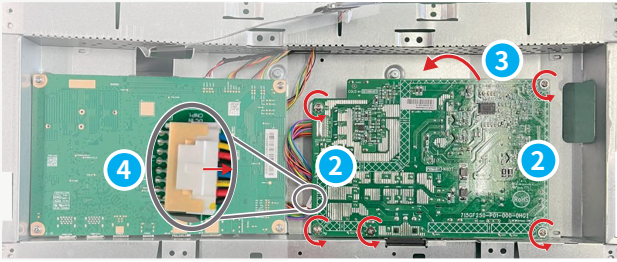
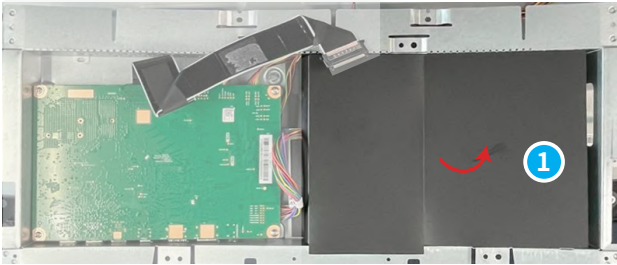

Power Board (Internal Power Supply) Assembly

1. Connect the cables to power board **1**
2. Flip the power board over **3**
3. Secure the screws **4** with a cross-head screwdriver. Paste the mylar to finish **5**.

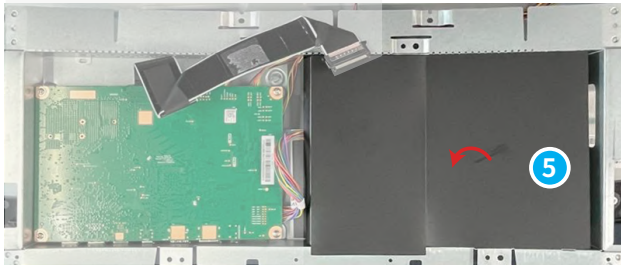
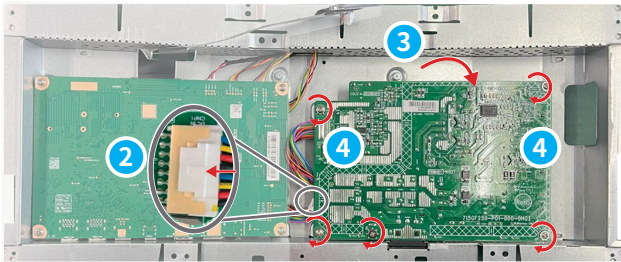
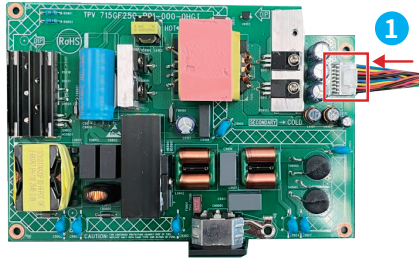

Navi Board & Navi Key

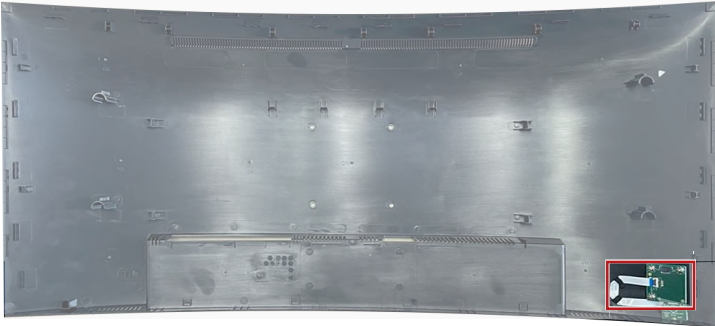

Navi Board & Navi Key Disassembly

1. Open the latch, and disconnect the LED board cable **1**. Remove the screws **2** with a cross-head screwdriver. Take out the Navi board **3**.

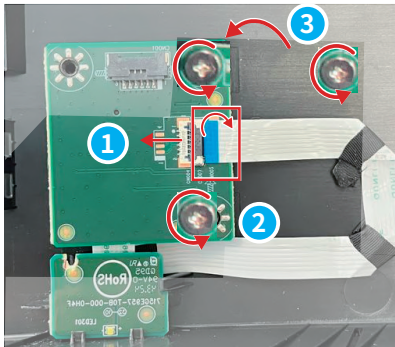

2. Remove the Navi key **4** to finish.

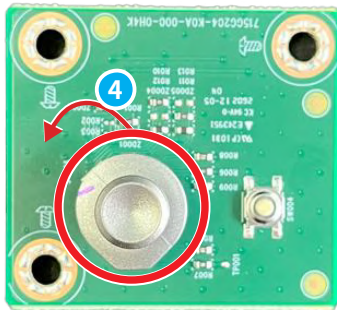

Navi Board & Navi Key Assembly

1. Insert the Navi key **1**.

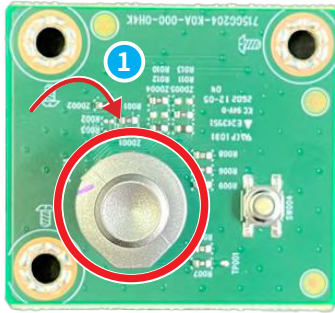

2. Align and replace the Navi board **2** to the rear cover. Secure the screws **3** with a cross-head screwdriver. Connect the LED board cable, and close the latch **4** to finish.

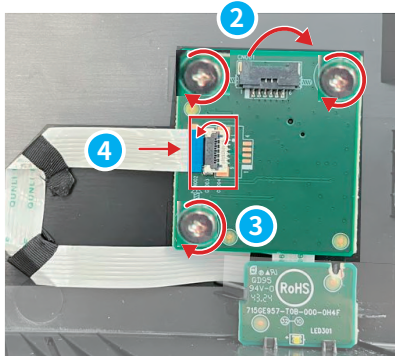

LED Board

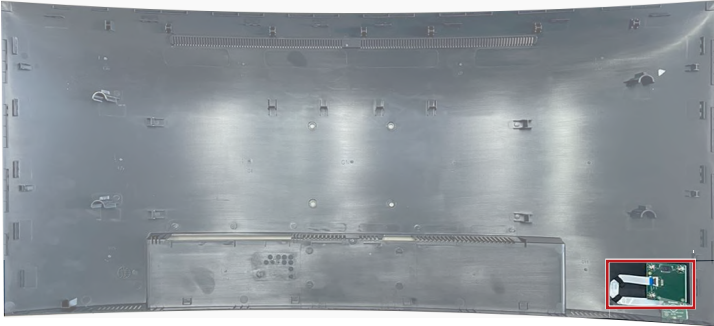

LED Board Disassembly

1. Open the latch, and disconnect the LED board cable ①. Lift and remove the LED board ②.

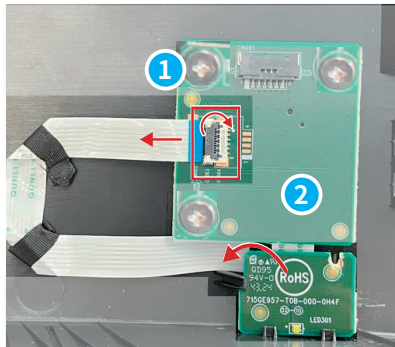

2. Open the latch, and disconnect the cable ③ to finish.

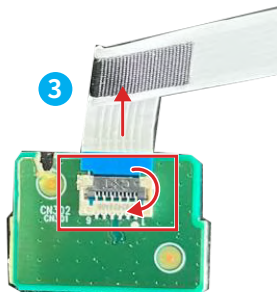

LED Board Assembly

1. Connect the cable to LED board ①.

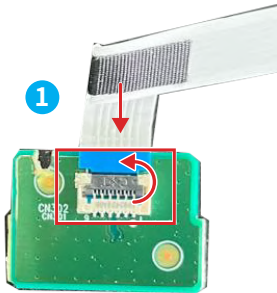

2. Align and replace the LED board ② to the rear cover. Connect the LED board cable, and close the latch ③ to finish.

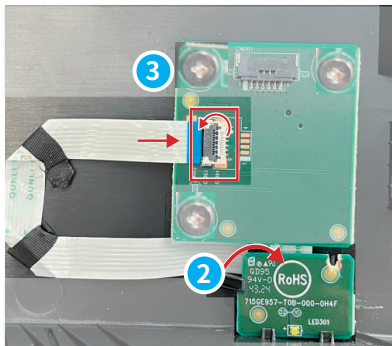

Powering Up After Maintenance

1. Connect the signal cable from the monitor to your PC. Connect the power cord to the monitor power jack and the electrical outlet. Turn on the monitor.
2. Depending on the monitor's signal ports, check the VGA, HDMI, DP ports in sequence. Changing the display to Red, Green, Blue, White and Black screens to check whether an image is abnormal.
3. Press the Menu key and adjust the Brightness or other functions to inspect the screen for abnormalities.
4. Check the Audio and volume control for abnormalities when connecting to various signal ports.
5. Reset the monitor after inspection. Turn off the monitor and disconnect all cables.

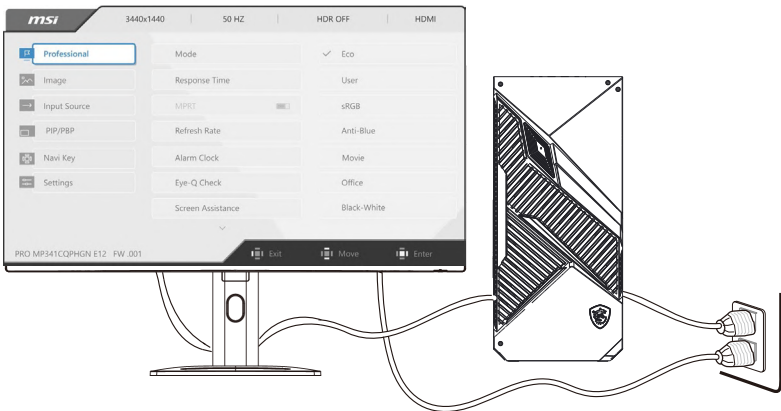

Troubleshooting

Users may refer to the following tips or visit [MSI Monitor Support](#) for quick and easy troubleshooting when encountering common problems with the product. It is always suggested that users contact the authorized MSI service center for advanced tech support if needed.

The power LED is off.

- Press the monitor power button again.
- Check if the monitor power cable is properly connected.

No image.

- Check if the computer graphics card is properly installed.
- Check if the computer and monitor are connected to electrical outlets and are turned on.
- Check if the monitor signal cable is properly connected.
- The computer may be in Standby mode. Press any key to activate the monitor.

The screen image is not properly sized or centered.

- Refer to Preset Display Modes to set the computer to a setting suitable for the monitor to display.

No Plug & Play.

- Check if the monitor power cable is properly connected.
- Check if the monitor signal cable is properly connected.
- Check if the computer and graphics card are Plug & Play compatible.

The icons, font or screen are fuzzy, blurry or have color problems.

- Avoid using any video extension cables.
- Adjust brightness and contrast.
- Adjust RGB color or tune color temperature.
- Check if the monitor signal cable is properly connected.
- Check for bent pins on the signal cable connector.

The monitor starts flickering or shows waves.

- Change the refresh rate to match the capabilities of your monitor.
- Update your graphics card drivers.
- Keep the monitor away from electrical devices that may cause electromagnetic interference (EMI).

How to change your monitor resolution settings

https://www.msi.com/support/technical_details/MNT_Resolution

About monitor response time

https://www.msi.com/support/technical_details/MNT_Perf_Product_Responding_Speed

Recycling Guidelines

In line with our commitment to environmental sustainability, this product is designed with separable plastic components to enhance plastic recycling quality. We kindly request that you responsibly recycle the recyclable plastic components of this product once it reaches the end of its useful life. Follow the instructions below to prepare plastic parts for recycling by eliminating non-recyclable materials.

Important

Before recycling the separable plastic components, please use diagonal pliers to remove all the screw bosses with copper sticks, if any.

Stand

1. Follow [Stand Disassembly](#) to remove the adjustable stand from the monitor.
2. By disassembling quick release fasteners **1** of the stand base to separate the stand and the base **2**.

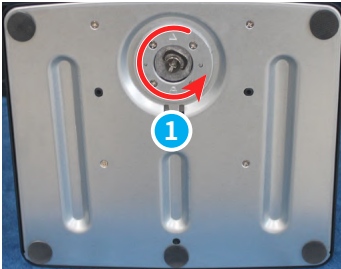

3. You'll see the stand and base separated.



4. Reverse the base. Tear off rubber pads **3** and remove screws **4** under with a cross-head screwdriver to open the base.

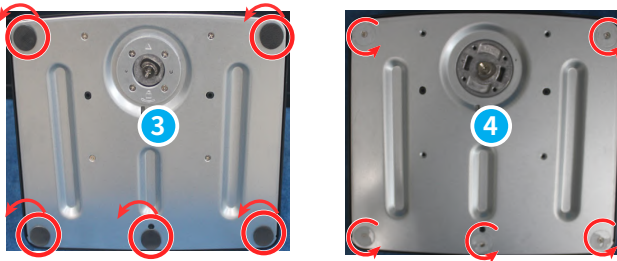

5. Open and take out the steel base plate **5**, the plastic base plate can be recycled by qualified recyclers.

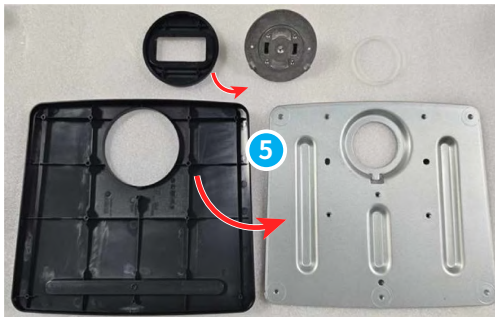

6. Use a cross-head screwdriver to loose stand and VESA screws **6**.

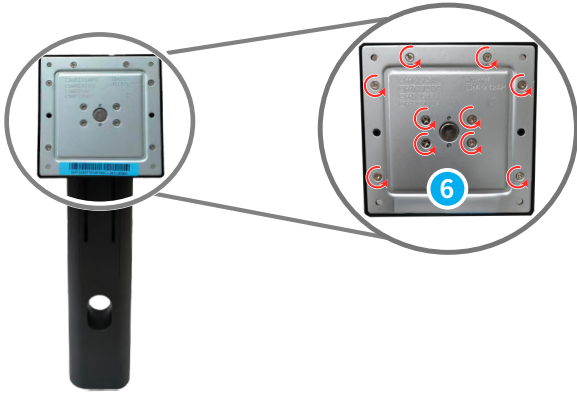

7. Use a pry tool to open up the steel and plastic VESA plate around the edge.

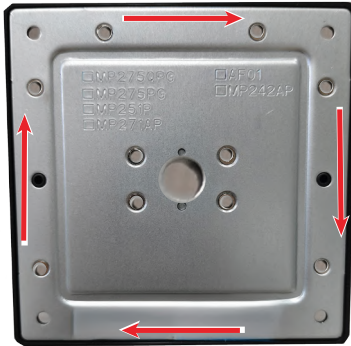

-
8. Both plates can be recycled by qualified recyclers.

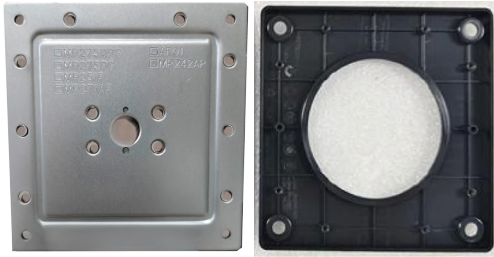

-
9. Take off the circular disc-shaped top **7** in the directions below **8** **9** **10**.

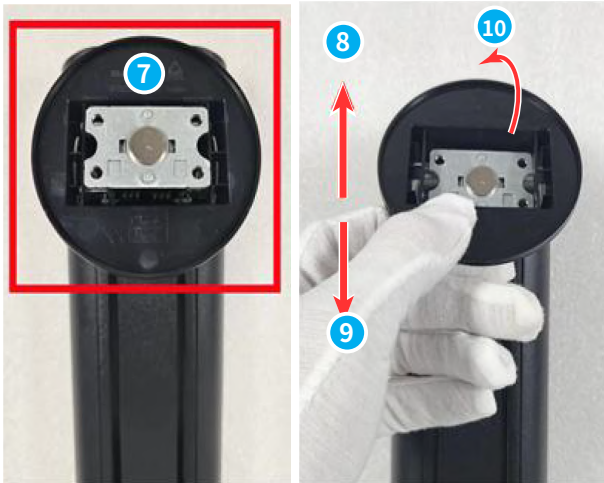

10. Remove screws 11 with a cross-head screwdriver to take the cap off 12.

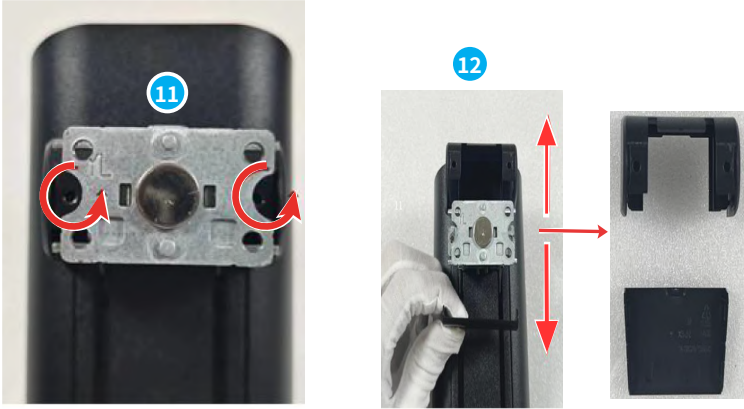

11. Use a pry tool to open the stand, including the front side: upper part 13 and the lower part 14, and the rear side 15 16 of the stand.

The front side

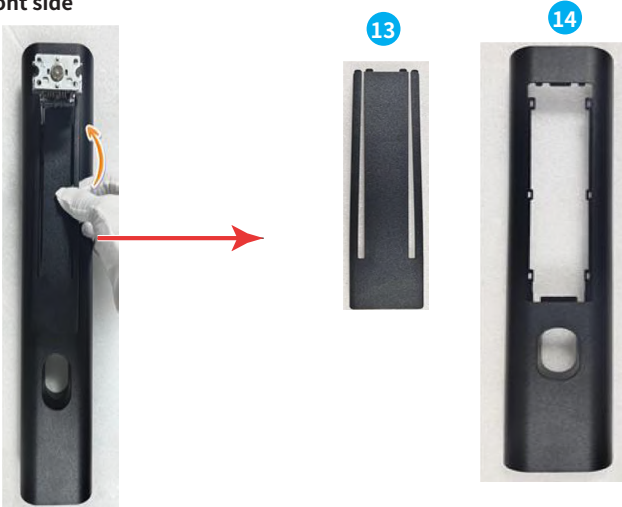

The rear side (Unscrew the screws with a cross-head screwdriver to separate all components.)

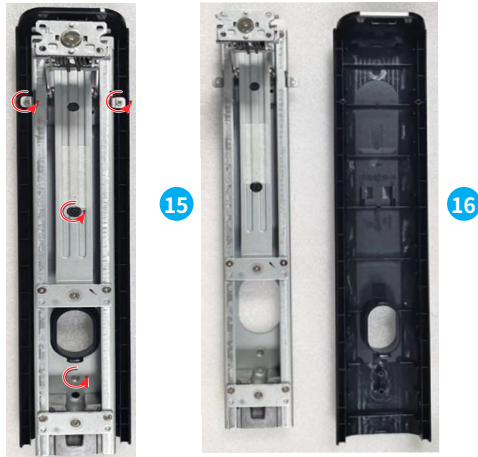

Rear Cover

Important

Before recycling the separated plastic parts, please use a cross-head screwdriver or the diagonal pliers to remove all the screw bosses with copper sticks, if any.

1. Follow [Rear Cover Disassembly](#) to remove the rear cover.
2. Remove navi key **1**, and use a cross-head screwdriver to remove screw bosses **2** with copper sticks. After disassembling all components, the rear cover can be recycled by qualified recyclers.



Removal of LCD bezel

1. Follow [LCD Panel & Shielding Cover Disassembly](#) to remove the LCD panel.
2. Place the display module on a curved foam pad. Remove the LCD panel bracket screws that secure to the LCD panel with a cross-head screwdriver **1**.

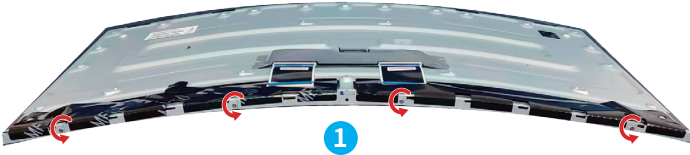

3. Carefully turn over the LCD panel. Peel the conductive cloth from the left side **2** and right side **3**. And then peel the conductive cloth carefully **4**.

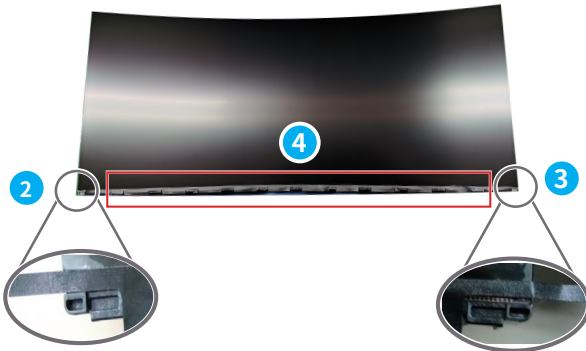

4. Turn over the LCD panel. Carefully remove the mylar **5** and then remove the LCD panel bracket **6**.

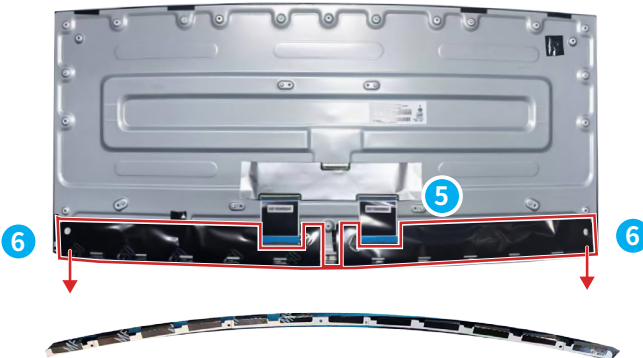

5. Remove the mylar on the LCD panel **7**. Peel the conductive cloth from the source board **8**. Open the latch and disconnect the cable from the source board **9**. Remove the T-CON board screws with a cross-head screwdriver **10**.

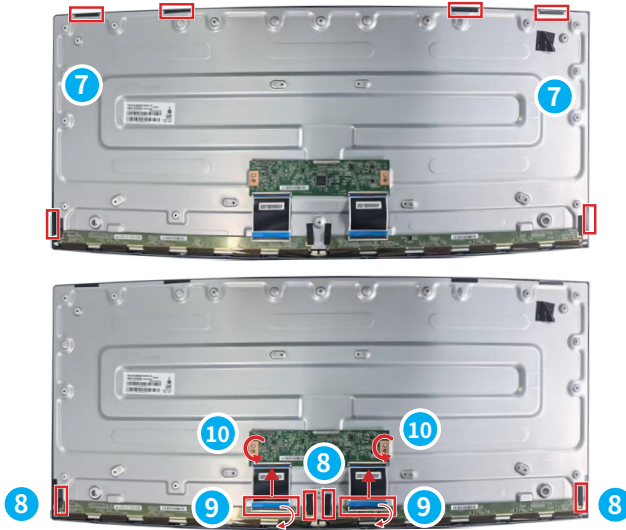

6. Remove the source board from back of LCD panel carefully **11**. Stick the source board to the LCD panel **12**.

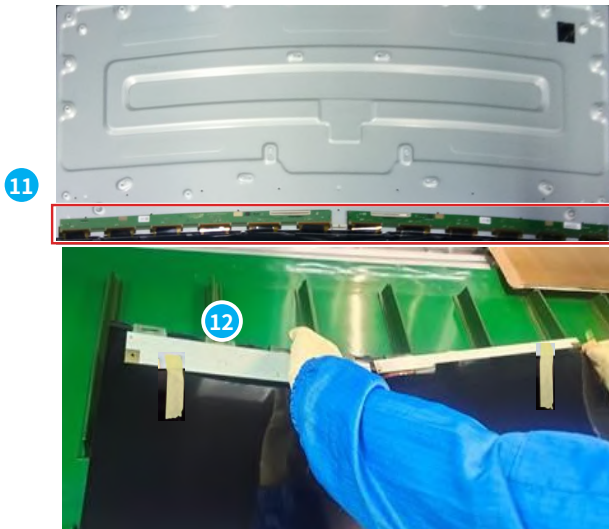

-
7. Use a pry bar to open the LCD bezel **13** and allow the rubber frame to separate from the LCD plate, which has a total 33 buckles.

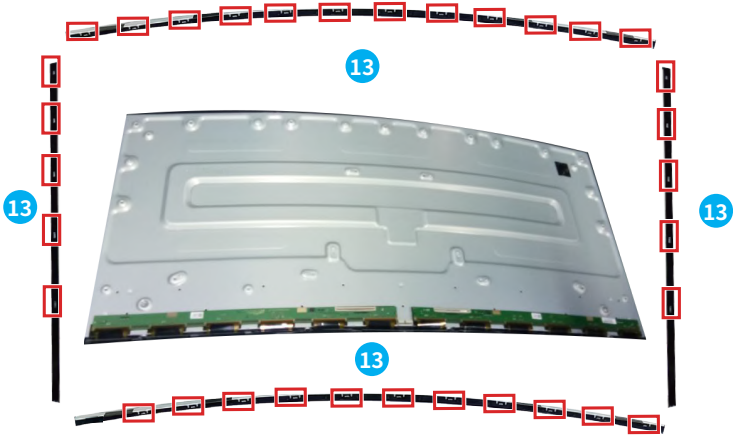

8. The LCD bezel **14** can be recycled .



 **Important**

1. This disassembly must be done in a clean room.
 2. You must wear an anti-static wrist strap when touching the motherboard and LCD panel.
 3. An ion fan must be available to remove static electricity.
 4. Please take this process gently to avoid LCD panel damage.
-

Product End-of-Life Instructions



Important

MSI Environmental Information

Information on MSI's Environmental initiatives, policies, programs and goals can be found at [Environmental Sustainability Policy](#).

Purpose

This information is to provide the guidance to recyclers on the presence of materials and components at the product level, as required by the EU WEEE and amending Directive.

Information on Component and Material Identification

The following substances, preparations, or components should be disposed of or recovered separately from other WEEE in compliance with Article 8 (2), (3) and (4) of EU Council Directive 2012/19/EU. Annex II contains an indicative list of EEE which falls within the categories set out in Annex I. It includes entries requiring disposal or recovery in compliance with the Waste Directive 2008/98/EC and, for listed WEEE components, provides mandatory treatment measures.

For detailed information, please refer to Annex VII of the WEEE Directive on the [ECHA website](#).

Identify materials for materials and components of the waste electrical and electronic equipment list.

*1: The following item numbers correspond with those in [Product Components and Accessories](#).

Materials	Item*1	Location
Polychlorinated biphenyl (PCB) containing capacitors and all polychlorinated biphenyls and polychlorinated terphenyls (PCB/PCT) containing electrical equipment	—	Absent
Mercury containing components, such as switches or backlighting lamps	—	Absent
Batteries	—	Absent
Printed circuit boards of mobile phones generally, and of other devices if the surface of the printed circuit board is greater than 10 square centimeters	7	Mainboard
	5	Navi Board
	8	Power Board
Toner cartridges, liquid and paste, as well as color toner	—	Absent
Plastic containing abominated flame retardants	—	Absent

Materials	Item* ¹	Location
Asbestos waste and components which contain asbestos	—	Absent
Cathode ray tubes	—	Absent
Chlorofluorocarbons (CFC), Hydrochlorofluorocarbons (HCFC) or Hydrofluorocarbons (HFC), Hydrocarbons (HC)	—	Absent
Gas discharge lamps	—	Absent
Liquid crystal displays (together with their casing where appropriate) of a surface greater than 100 square centimeters and all those back-lighted with gas discharge lamps	4	LCD Panel
External electric cables	—	Absent
Components containing refractory ceramic fibers	—	Absent
Components containing radioactive substances, or materials that become radioactive	—	Absent
Electrolytic capacitors containing substances of concern (height > 25 mm, diameter > 25 mm or proportionately similar volume)	8	Power Board
Beryllium and its compounds (including Beryllium Oxide)	—	Absent
Liquids	—	Absent

Product Take-Back Service

Waste electrical equipment may contain hazardous substances and thus endanger human health & the environment. Proper disposal is therefore required. MSI provides free recycling of EPEAT-registered products to ensure that the product reaches the end of its useful life and that it is recycled responsibly.

To properly recycle your equipment through this service, please follow the steps:

1. Please delete your personal data from your waste equipment.
2. [CLICK HERE](#) to learn how to recycle your end-of-life product.
3. Find the MSI recycling location nearby on the website.
4. Contact the designated recycling location by phone or email to schedule your pickup. The customers are responsible for any shipping and delivery charges.

OSD Setup

OSD Setup

This chapter provides you with essential information on OSD Setup.



All information is subject to change without prior notice.

Navi Key

The monitor comes with a Navi Key, a multi-directional control that helps navigate the On-Screen Display (OSD) menu.

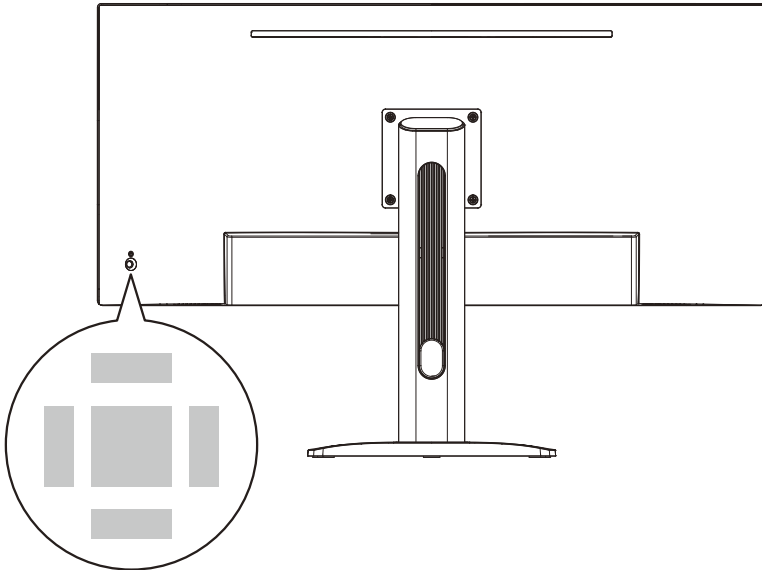

Up/ Down/ Left/ Right:

- selecting function menus and items
- adjusting function values
- entering into/exiting from function menus

Middle:

- launching the On-Screen Display (OSD)
- entering submenus
- confirming a selection or setting

Hot Key

- Users may enter into preset function menus by moving the Navi Key up, down, left or right when the OSD menu is inactive.
- Users may customize their own Hot Keys to enter into different function menus.

OSD Menus

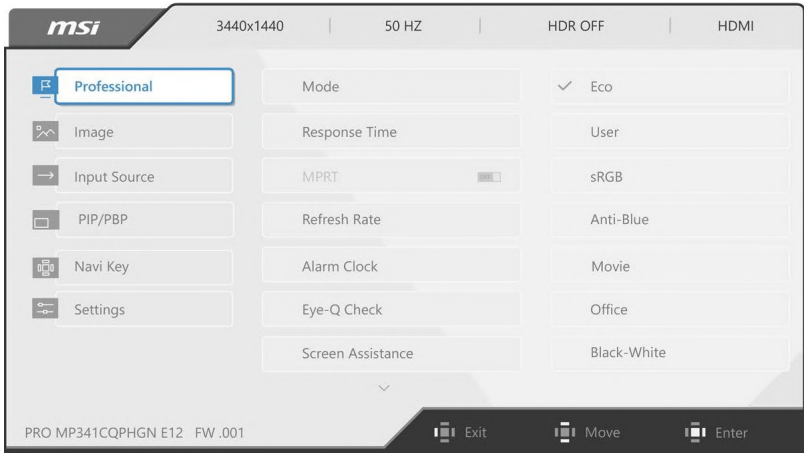

Image

1st Level Menu	2nd/3rd Level Menu	Description
Brightness	0-100	Properly adjust Brightness according to the surrounding lighting.
Contrast	0-100	<ul style="list-style-type: none"> Properly adjust Contrast to relax your eyes.
Sharpness	0-5	<ul style="list-style-type: none"> Sharpness improves clarity and details of images.
Image Enhancement	OFF	<ul style="list-style-type: none"> Image Enhancement enhances image edges to improve their acutance.
	Weak	
	Medium	
	Strong	
	Strongest	
Low Blue Light	OFF	<ul style="list-style-type: none"> Low Blue Light protects your eyes against blue light. When enabled, Low Blue Light adjusts the screen color temperature to a more yellow glow. When Mode is set to Anti-Blue, it is mandatory to enable Low Blue Light.
	ON	

1st Level Menu	2nd/3rd Level Menu	Description						
HDCR	OFF	<ul style="list-style-type: none"> HDCR enhances image quality by increasing the contrast of images. Activating HDCR will affect: <table border="1" data-bbox="593 268 927 367"> <thead> <tr> <th>Affected Function</th> <th>Function Status</th> </tr> </thead> <tbody> <tr> <td>» Brightness</td> <td>Unable to select</td> </tr> <tr> <td>» MPRT</td> <td>Set to OFF</td> </tr> </tbody> </table> 	Affected Function	Function Status	» Brightness	Unable to select	» MPRT	Set to OFF
	Affected Function		Function Status					
» Brightness	Unable to select							
» MPRT	Set to OFF							
ON								
Color Temperature	Cool	<ul style="list-style-type: none"> Use Up or Down Button to select and preview mode effects. Press the Middle Button to confirm and apply your mode type. Users can adjust Color Temperature in Customization mode. 						
	Normal							
	Warm							
	Customization		R (0-100)					
			G (0-100)					
B (0-100)								

Input Source

1st Level Menu	2nd Level Menu	Description
HDMI™		<ul style="list-style-type: none"> Users can adjust Input Source in any mode.
DP		
Type C		
Auto Scan	OFF	<ul style="list-style-type: none"> Users can use the Navi Key to select Input Source at below status: <ul style="list-style-type: none"> While “Auto Scan” is set to “OFF” with the monitor at power saving mode; While “No Signal” message box is shown on the monitor.
	ON	

PIP/PBP

1st Level Menu	2nd/3rd Level Menu		Description																
OFF			<ul style="list-style-type: none"> PIP (Picture in Picture) allows users to simultaneously display multiple video sources on one screen. One program is displayed on the full screen at the same time as one or more other programs are displayed in inset windows. PBP (Picture by Picture) is a similar feature that displays two input sources side-by-side on the screen. Display Switch allows users to switch between primary and secondary input sources. If there is only one signal input, the Display Switch and Audio Switch will be grayed out. Activating PIP/PBP will affect: <table border="1" data-bbox="601 608 926 871"> <thead> <tr> <th>Affected Function</th> <th>Function Status</th> </tr> </thead> <tbody> <tr> <td>» HDMI™ Console Mode</td> <td>Unable to select</td> </tr> <tr> <td>» Adaptive-Sync</td> <td>Set to OFF</td> </tr> <tr> <td>» MPRT</td> <td>Set to OFF & unable to select</td> </tr> <tr> <td>» Response Time</td> <td>Set to OFF & unable to select</td> </tr> <tr> <td>» HDMI™ CEC</td> <td>Set to OFF & unable to select</td> </tr> <tr> <td>» PIP: Screen Size 1:1</td> <td>Set to Auto & unable to select</td> </tr> <tr> <td>» PBP: Screen Size</td> <td>Set to Auto & unable to select</td> </tr> </tbody> </table> 	Affected Function	Function Status	» HDMI™ Console Mode	Unable to select	» Adaptive-Sync	Set to OFF	» MPRT	Set to OFF & unable to select	» Response Time	Set to OFF & unable to select	» HDMI™ CEC	Set to OFF & unable to select	» PIP: Screen Size 1:1	Set to Auto & unable to select	» PBP: Screen Size	Set to Auto & unable to select
Affected Function	Function Status																		
» HDMI™ Console Mode	Unable to select																		
» Adaptive-Sync	Set to OFF																		
» MPRT	Set to OFF & unable to select																		
» Response Time	Set to OFF & unable to select																		
» HDMI™ CEC	Set to OFF & unable to select																		
» PIP: Screen Size 1:1	Set to Auto & unable to select																		
» PBP: Screen Size	Set to Auto & unable to select																		
PIP	Source	HDMI™																	
		DP																	
		Type C																	
	PIP Size	Small																	
		Medium																	
		Large																	
	Location	Left Top																	
		Right Top																	
		Left Bottom																	
		Right Bottom																	
Display Switch																			
Audio Switch																			
PBP	Source 1	HDMI™																	
		DP																	
		Type C																	
	Source 2	HDMI™																	
		DP																	
		Type C																	
	Display Switch																		
	Audio Switch																		

Navi Key

1st Level Menu	2nd Level Menu	Description
Up Down Left Right	OFF	<ul style="list-style-type: none"> All Navi Key items can be adjusted via OSD Menus.
	Brightness	
	Mode	
	Alarm Clock	
	Input Source	
	PIP/PBP Mode	
	Refresh Rate	
	Info. On Screen	
	Audio Volume	
	KVM	

Settings

1st Level Menu	2nd Level Menu	Description
Language	繁體中文	<ul style="list-style-type: none"> Users have to press the Middle Button to confirm and apply the Language setting. Language is an independent setting. Users' own language setting will override the factory. When users set Reset to Yes, Language will not be changed.
	English	
	Français	
	Deutsch	
	Italiano	
	Español	
	한국어	
	日本語	
	Русский	
	Português	
	简体中文	
	Bahasa Indonesia	
	Türkçe	
(More languages coming soon)		

1st Level Menu	2nd Level Menu	Description				
Transparency	0-5	<ul style="list-style-type: none"> Users can adjust Transparency in any mode. 				
OSD Time Out	5-30s	<ul style="list-style-type: none"> Users can adjust OSD Time Out in any mode. 				
Power Button	OFF	<ul style="list-style-type: none"> When set to OFF, users can press the power button to turn off the monitor. 				
	Standby	<ul style="list-style-type: none"> When set to Standby, users can press the power button to turn off the panel and backlight. 				
HDMI™ CEC	OFF	<ul style="list-style-type: none"> HDMI™ CEC (Consumer Electronics Control) supports Sony PlayStation®, Nintendo® Switch™, Xbox Series X S consoles and various audio-visual devices that are CEC-capable. If HDMI™ CEC is set to ON: <ul style="list-style-type: none"> The monitor will automatically power on when the CEC device is turned on. The CEC device will enter power saving mode when the monitor is turned off. When Sony PlayStation®, Nintendo® Switch™, or Xbox Series X S console is connected, Mode will be automatically set to default mode and can be adjusted to users' preferred mode later. 				
	ON					
Type C PD Charge	OFF	<ul style="list-style-type: none"> This function enables users to charge their devices through a USB Type-C connector. 				
	ON					
Info. On Screen	OFF	<ul style="list-style-type: none"> The information of the monitor status will be shown on the right side of the screen. Activating Info. On Screen will affect: <table border="1" data-bbox="532 925 851 989"> <thead> <tr> <th>Affected Function</th> <th>Function Status</th> </tr> </thead> <tbody> <tr> <td>» Eye-Q Check</td> <td>Set to OFF</td> </tr> </tbody> </table> 	Affected Function	Function Status	» Eye-Q Check	Set to OFF
	Affected Function		Function Status			
» Eye-Q Check	Set to OFF					
ON						
Audio Volume	0-100	<ul style="list-style-type: none"> Users can adjust Audio Volume in any mode. 				
Reset	YES	<ul style="list-style-type: none"> Users can Reset and restore settings to original OSD Default in any mode. 				
	NO					